

MVB-UDP

Datasheet

Email: yacer@yacer.cn

Web: www.yacer.com.cn

Foreword

Notational Conventions

The following categorized signal words with defined meaning might appear in the manual.







Signal Words	Meaning
 DANGER	Indicates a high potential hazard which, if not avoided, will result in death or serious injury.
 CAUTION	Indicates a potential risk which, if not avoided, could result in property damage, data loss, lower performance, or unpredictable result.
 ANTISTATIC	Indicates static sensitive equipment.
 DANGER! ELECTRIC SHOCK	Indicates High voltage danger.
 TIPS	Provides methods to help you solve a problem or save you time.
 NOTE	Provides additional information as the emphasis and supplement to the text.

Table of Contents

Foreword	I
1 Overview	4
1.1 Introduction	4
1.2 Features	4
1.3 Applications	4
1.4 Order Information	5
1.5 Technical Specifications	5
1.6 Mechanical Dimension Drawing	6
2 Hardware and Physical Interfaces	7
2.1 Appearance	7
2.2 LED Indicators	7
2.3 Extended Pin Definition	8
2.3.1 X1: 1x13 2.54mm pitch connector	8
2.3.2 X2: 1x13 2.54mm pitch connector	8
3 System and Configuration	10
3.1 Module Configuration	10
3.1.1 Static configuration	10
3.1.2 Dynamic configuration	10
3.2 Startup Process	11
4 Building Configuration Environment	12
4.1 Connect Management Computer to MVB-UDP	12
4.1.1 Configure with special DMS-UART interface	12
4.1.2 Configuration with Ethernet interface	12
4.2 Get Configuration Management Software yacer-DMS	13
4.3 Run yacer-DMS Software	13
4.4 Select & Open Configuration Serial Port	13
4.5 Main Window of yacer-DMS	14
4.6 Statistical Report	14
4.6.1 Control panel	14
4.6.2 Receive & Transmit indication panel	14
4.6.3 Information panel	15
4.7 Configure Device	15
5 Function and Configuration	17
5.1 Interface Configuration	17
5.1.1 Ethernet interface configuration	17
5.1.2 Serial port configuration	17
5.1.3 System configuration	18
5.2 MVB Configuration	18
5.2.1 MVB interface configuration	18
5.2.2 Ethernet, serial to MVB configuration	19
5.2.3 MVB to Ethernet, serial configuration	20

5.2.4 PD acquisition	20
5.2.5 PD port configuration table	20
5.3 TRDP Receive Configuration	20
5.4 TRDP Send Configuration	21
5.5 Firmware Version Upgrade	21
5.5.1 Start upgrade	21
5.5.2 Select version file	22
5.5.3 Complete upgrade	22
5.5.4 Confirm upgrade	23
5.6 Reboot Device	23
5.7 Ping	24
6 Hardware Development	25
7 Software Development	25

1 Overview

1.1 Introduction

The Yacer MVB-UDP embedded slave network card module, providing a set of full-featured MVB redundant interfaces, one 100M Ethernet PHY interface, and one UART extended serial port to realize the protocol conversion between MVB, UDP and serial port, and optionally support TRDP protocol.

46.5 × 48mm tiny size, 2.54mm pin connector. + 5V power supply, low power consumption. Industrial wide temperature, suitable for embedded applications.

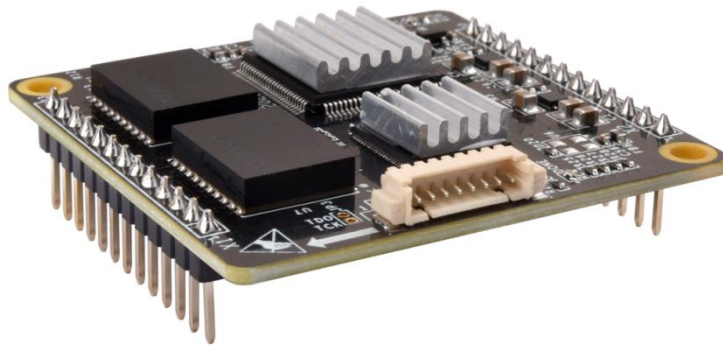

1.2 Features

- One 10/100M Ethernet PHY interface, supporting TRDP protocol;
- One UART extended serial port;
- Full feature MVB redundant interface, Support EMD, ESD+ interface, IEC61375 compliant;
- Supports MVB slave protocol, multiple PD source and sink ports;
- Supports PD data acquisition function of MVB-bus;
- +5V power supply, low power consumption;
- Small size, Industrial wide temperature.

1.3 Applications

- Protocol conversion between MVB and Ethernet;
- Protocol conversion between MVB and serial port;
- MVB bus PD data monitoring;
- Protocol conversion between TRDP and serial port;
- Train Control and Management System (TCMS);
- Train Communication Network (TCN);
- Embedded development and application.

1.4 Order Information

Model	Description
MVB-UDP-200	1 x dual redundancy MVB + 1 x Ethernet PHY + 1 x UART

1.5 Technical Specifications

Item	Parameters	Details
MVB Interface	Media support	EMD, ESD+
	Device class	Class 1
	Device capabilities	Device_Status, Process_Data(PD)
	Number of PD ports	16
	Isolation	2.5 kVrms
Ethernet Interface	Number	1 x 10/100M PHY
	Rate	10/100 Mbps, supports MDI/MDIX adaptive
	Protocol	TRDP、UDP
	Programming interface	UDP Server, UDP Client, supports unicast / multicast / broadcast
Extended Serial Port	Level standard	3.3V LVCMOS
	Working mode	Asynchronous UART
	Baud rate	≤ 921.6 Kbps
Configuration Management	Configuration interface	Special DMS-UART interface (by DMS-UART-8P cable) Ethernet interface
	Configuration tool	yacer-DMS configuration management software
Power Requirements	Power supply	+5 VDC
	Power consumption	< 2W
Mechanical	Connector	Two 2.54mm pitch 13-pin single-row male connectors

Item	Parameters	Details
Characteristics	Dimensions	46.5 x 48 mm
	Weight	15 g
Operating Environment	Operating temperature	-40 ~ +85°C
	Storage temperature	-40 ~ +85°C
	Operating humidity	5 ~ 95% RH (no condensation)



NOTE: If you need to support more MVB PD ports, please contact the manufacturer.

1.6 Mechanical Dimension Drawing

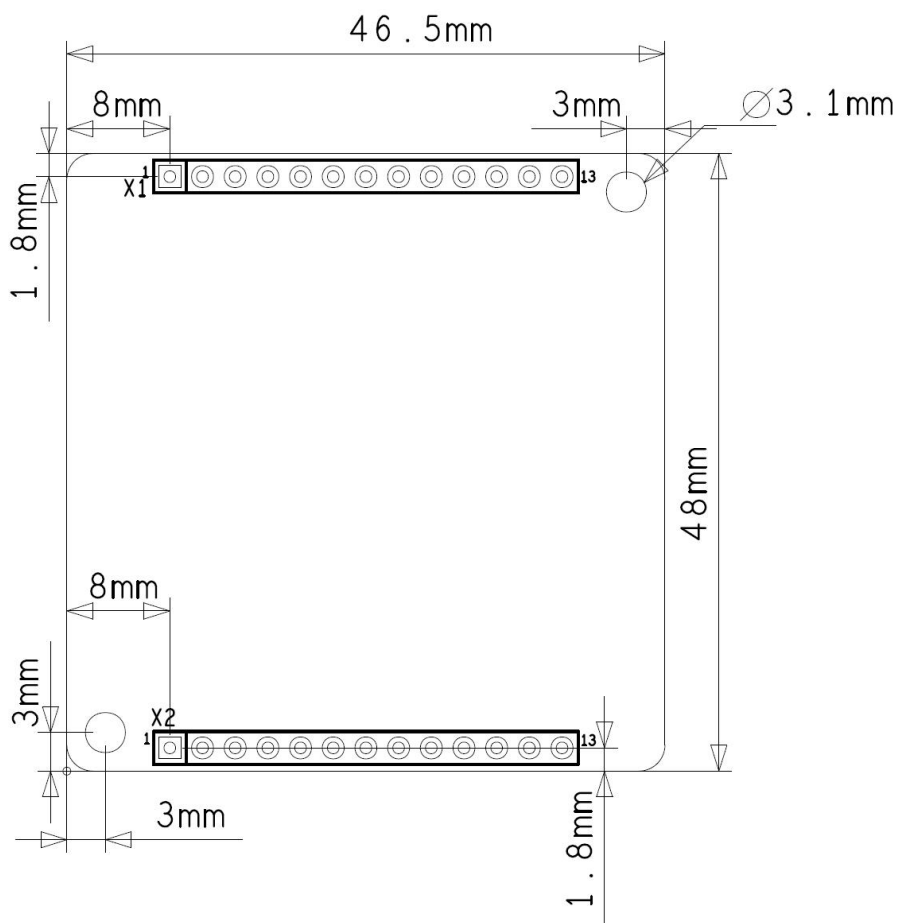

2 Hardware and Physical Interfaces

2.1 Appearance

The top and bottom view of MVB-UDP are as follows, and the signals are drawn out through connector X1 and X2.

X3 is the configuration interface used to connect the DMS-UART-8P configuration cable and configure it online through the management computer's USB interface.

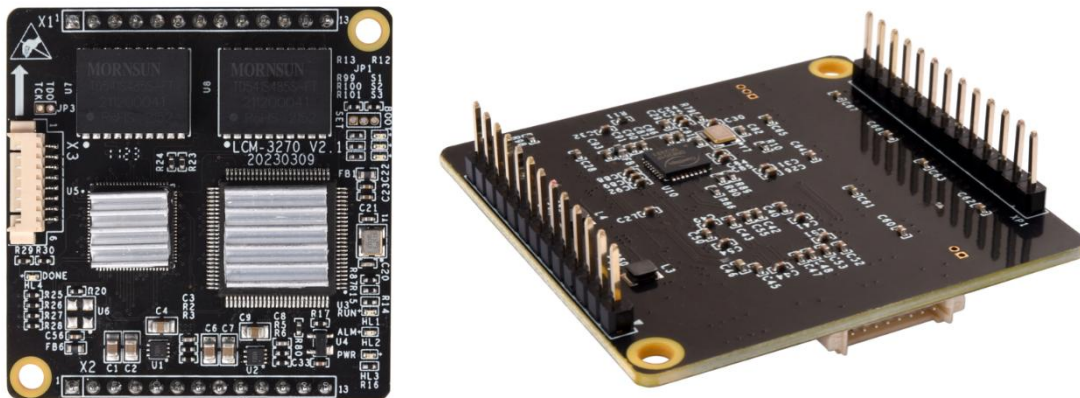

2.2 LED Indicators

Item	Description
RUN	Running indicator, green light flashes during normal operation
ALM	Alarm indicator <ul style="list-style-type: none"> Initialization phase blinking: waiting for the host computer configuration command Normal operation status off: the device is working normally Normal operation status on: device failure
PWR	Power indicator, always on after power on

2.3 Extended Pin Definition

2.3.1 X1: 1x13 2.54mm pitch connector

Pin	Name	Type	Description
1	MVB_A_5V_OUT	O	MVB interface Line A power output
2	MVB_A_TxD +	O	MVB interface Line A transmit positive (+)
3	MVB_A_TxD -	O	MVB interface Line A transmit negative (-)
4	MVB_A_RxD +	I	MVB interface Line A receive positive (+)
5	MVB_A_RxD -	I	MVB interface Line A receive negative (-)
6	MVB_A_GND		MVB interface Line A ground
7	NC		Standby, this pin must be left floating
8	MVB_B_5V_OUT	O	MVB interface Line B power output
9	MVB_B_TxD +	O	MVB interface Line B transmit positive (+)
10	MVB_B_TxD -	O	MVB interface Line B transmit negative (-)
11	MVB_B_RxD +	I	MVB interface Line B receive positive (+)
12	MVB_B_RxD -	I	MVB interface Line B receive negative (-)
13	MVB_B_GND		MVB interface Line B ground



NOTE: User must short connect TxD+ and RxD+, TxD- and RxD- of MVB.

2.3.2 X2: 1x13 2.54mm pitch connector

Pin	Name	Type	Description
1	GND		Logical Ground
2	ETH_RX+		Rx+ for Ethernet PHY interface, external network transformer required
3	ETH_RX-		Rx- for Ethernet PHY interface, external network transformer required

Pin	Name	Type	Description
4	ETH_TX+		Tx+ for Ethernet PHY interface, external network transformer required
5	ETH_TX-		Tx- for Ethernet PHY interface, external network transformer required
6	ETH_LED	O	Ethernet Link/Act indication, drive LED positive
7	UART_TxEn_LED	O	<ul style="list-style-type: none"> • UART Half-duplex: Serial transmitter enable, enable level is high • UART Full-duplex: MVB transceiver indication, drive LED positive
8	UART_RxD	I	Serial port data receive
9	UART_TxD	O	Serial port data transmit
10	RESET_IN	I	Module reset, active low. Power-On Reset supported, Pin can be suspended.
11	NC		Standby, this pin must be left floating
12	+5V	I	Power input, +5 VDC
13	GND		Logical Ground

3 System and Configuration

3.1 Module Configuration

MVB-UDP provides a variety of easy and flexible configuration functions to meet the different application scenarios of users.

3.1.1 Static configuration

The MVB-UDP module has internal FLASH memory to save the configuration. When the module is in normal running operation, the user can configure the MVB-UDP using the following methods:

- Interactive configuration via the DMS-UART interface using the yacer-DMS configuration management software;
- The host computer gives the configuration commands through the UART interface.

The new configuration generated by the above method is saved in FLASH and the configuration takes effect after the module is rebooted.

3.1.2 Dynamic configuration

When the module is powered up, the UART interface is initialized with the baud rate parameters saved in FLASH (factory default 115200bps) and waits for a configuration command from the host computer.

If a legitimate configuration command is received within the waiting time window, the MVB-UDP is initialized with the configuration parameters carried by the command. If the configuration command is not received within the timeout, the MVB-UDP is initialized with the configuration saved in FLASH.

The size of the wait time window is 5 seconds by default and can be modified by static configuration. If the window is set to 0, the configuration is initialized by loading directly from FLASH.

3.2 Startup Process

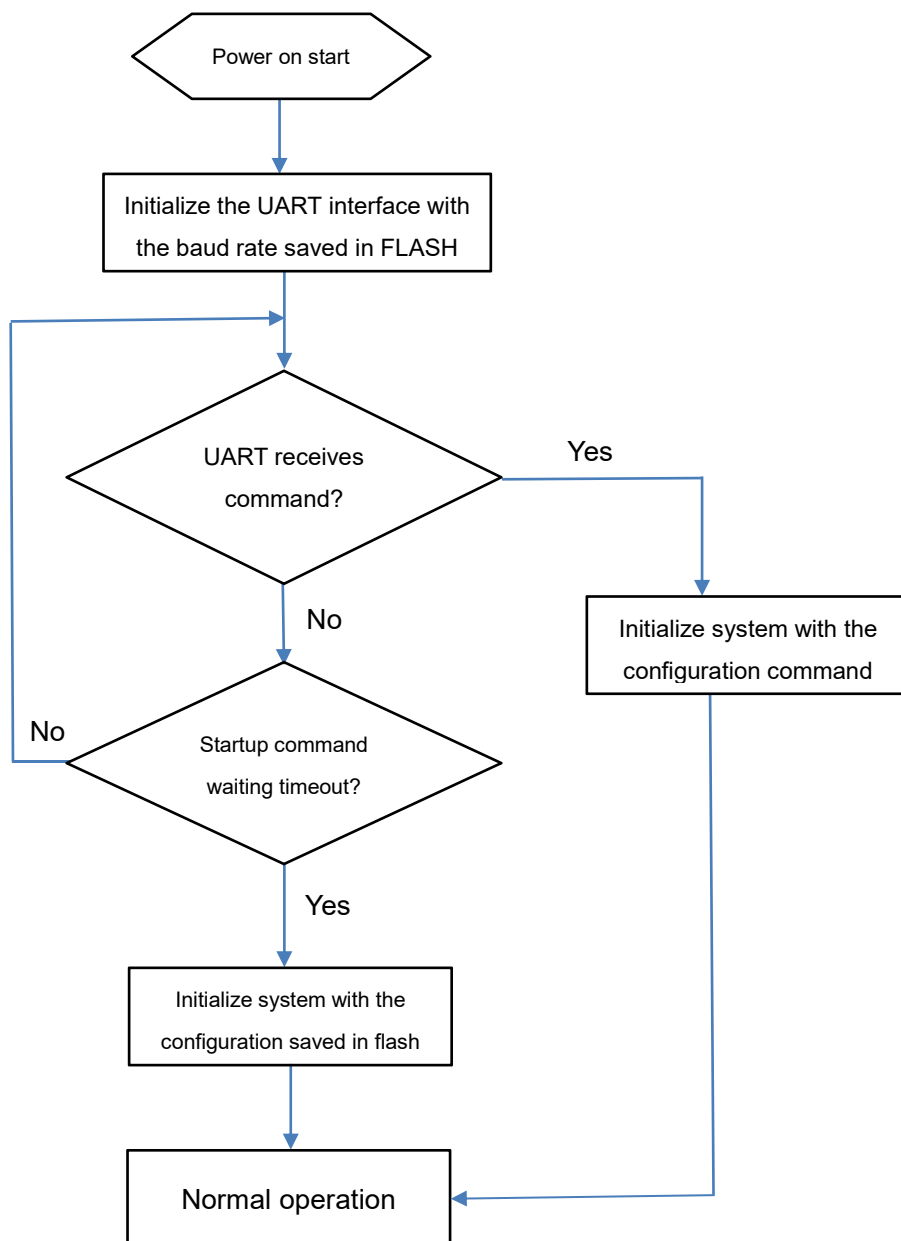

4 Building Configuration Environment

4.1 Connect Management Computer to MVB-UDP

MVB-UDP provides a variety of configuration management methods to meet different application scenarios.

After the MVB-UDP is configured, the configuration parameters are saved in FLASH on the MVB-UDP board, and will be automatically loaded to work every time MVB-UDP is powered on or restarted in the future.

4.1.1 Configure with special DMS-UART interface

Connect the special DMS-UART interface (X3) of MVB-UDP to the USB interface of the computer with the DMS-UART-8P configuration cable.



4.1.2 Configuration with Ethernet interface

Users can connect the MVB-UDP to the management computer via Ethernet, and run yacer-DMS configuration management software on the computer to configure and manage the MVB-UDP.

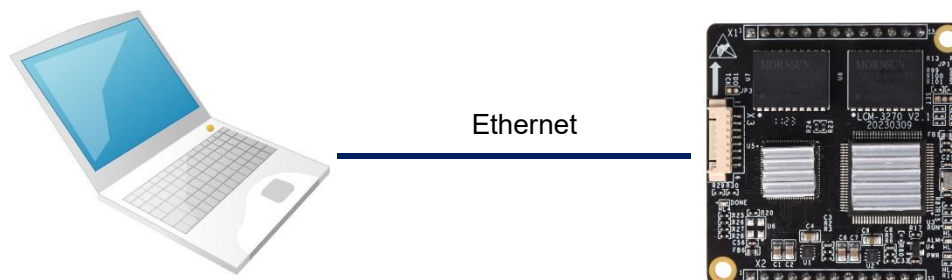

4.2 Get Configuration Management Software yacer-DMS

The user can obtain a compressed package yacer-DMS.zip of configuration management software in the following ways:

- In the “Softwares” directory of the accompanied U disk of MVB-UDP;
- Software channel on the official website (www.yacer.com.cn).

4.3 Run yacer-DMS Software

As the free-installation application software, unzip yacer-DMS.zip, enter the working directory and double click the file yacer-DMS.exe to run.

4.4 Select & Open Configuration Serial Port

When DMS-UART-8P configuration line is connected to the management computer USB interface, the computer will add a USB simulation serial port.

Click the “Interface” button on the toolbar to pop up the “Host Interface for DMS” configuration dialog. Enter the “Serial” page, select the serial port of the computer connected to MVB-UDP from the drop-down list, and click “Open Serial” button.

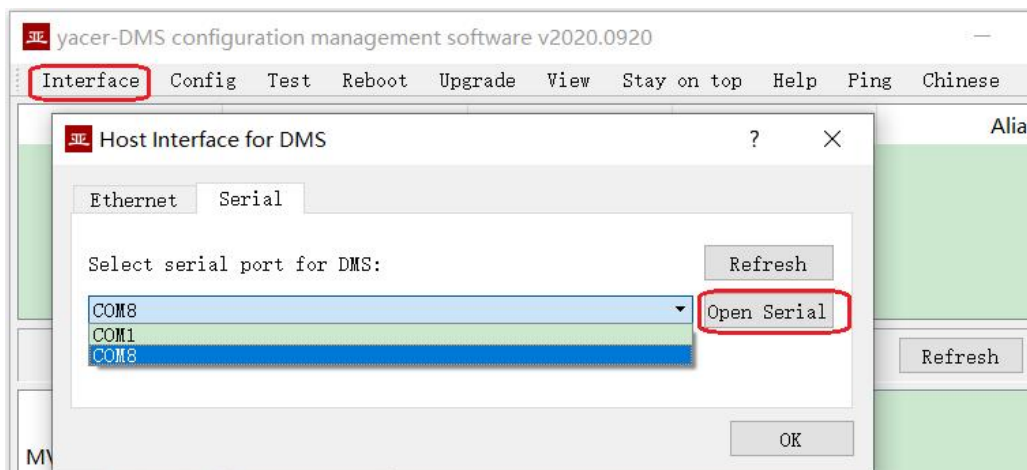

If the serial port is successfully opened, the status is as follows:



4.5 Main Window of yacer-DMS

The following figure is the main interface of the configuration management software, which can be divided into three parts:

- **Toolbar:** Functional operation buttons;
- **Device List:** Displaying the basic information and operation status of online devices;
- **Statistical Report:** Displaying the receive/transmit indication & statistics, and device details.

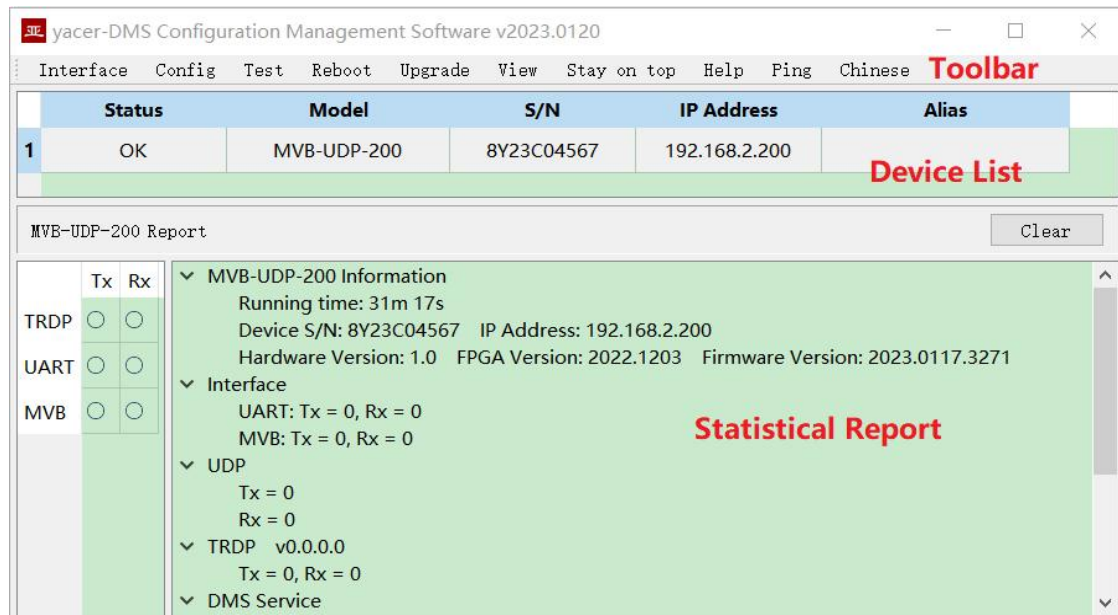

4.6 Statistical Report

The statistical report has three panels: control panel, receive/transmit indication panel and information panel.

4.6.1 Control panel

Statistical report data is refreshed once per second and can be cleared by clicking the "Clear" button.

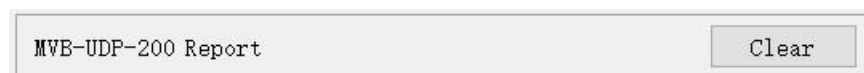

4.6.2 Receive & Transmit indication panel

- **Tx:** The interface sends a frame of data, corresponding Tx indicator

	Tx	Rx
TRDP	<input type="radio"/>	<input type="radio"/>
UART	<input type="radio"/>	<input type="radio"/>
MVB	<input type="radio"/>	<input type="radio"/>

- blinks once;
- Rx: The interface receives a frame of data, corresponding Rx indicator blinks once.

4.6.3 Information panel

The right side of the statistical report is the information panel, which can display the following contents:



- Device information: Running time, S/N and Version number;
- MVB: MVB device status information;
- Interface: Receive/transmit statistics of MVB and UART interface;
- UDP: Receive/transmit statistics of UDP packets on Ethernet interface;
- TRDP: Receive/transmit statistics of TRDP PD;
- DMS Service: Configuration management message receive/transmit statistics.

4.7 Configure Device

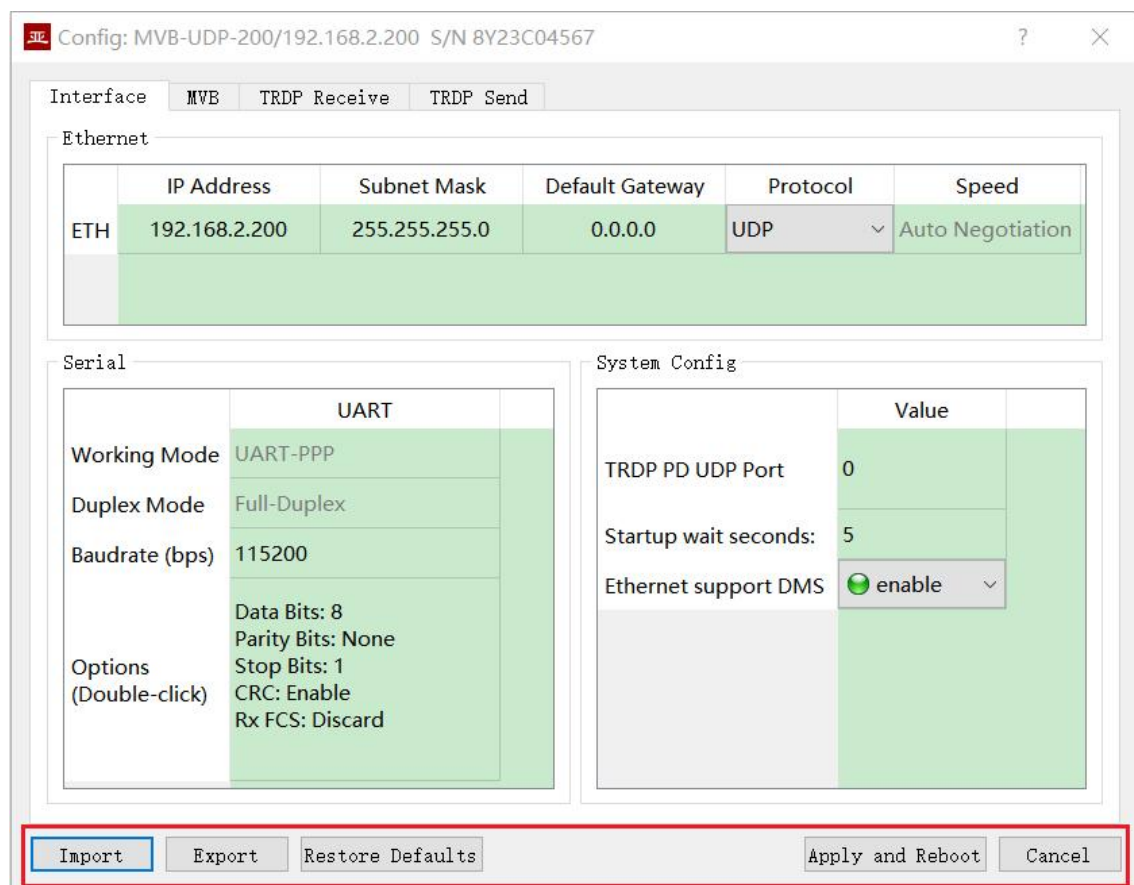
Click the "Device Configuration" button on the toolbar or double-click the selected device in the device list, yacer-DMS pops up the configuration dialog.

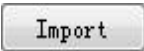
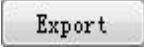
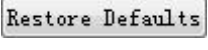
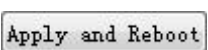

The following action buttons are included at the bottom of the dialog box.

Button	Function
	Open the configuration file, read the configuration parameters refresh the configuration dialog
	Export configuration parameters from the configuration dialog to a file for saving
	Refresh the configuration dialog with the factory parameters
	Write the configuration parameters in the dialog to the device, and restart the device to make the configuration take effect
	Cancel current configuration operation

5 Function and Configuration

5.1 Interface Configuration

This page is used to configure the working modes and system parameters of the Ethernet interface and serial port.

5.1.1 Ethernet interface configuration

Users can modify the IP address, subnet mask and default gateway of MVB-UDP.

The default gateway is set to 0 when there is no need to communicate with devices across network segments.

When working in TRDP protocol, the Ethernet port is forced to be 100M full duplex.

Ethernet

	IP Address	Subnet Mask	Default Gateway	Protocol	Speed
ETH	192.168.2.200	255.255.255.0	0.0.0.0	UDP	Auto Negotiation
				UDP	
				TRDP	

5.1.2 Serial port configuration

It is possible to communicate with the UART of the host computer through the extended serial port to transmit MVB data or control commands. Since UART sends and receives character stream without head and tail, in order to transmit an MVB packet, a UART-PPP frame is constructed by adding 0x7E as the start and end flag at the beginning and end of the packet, and inserting a frame check sequence.

Serial

	UART
Working Mode	UART-PPP
Duplex Mode	Full-Duplex
Baudrate (bps)	115200
Options (Double-click)	Data Bits: 8 Parity Bits: None Stop Bits: 1 CRC: Enable Rx FCS: Discard

5.1.3 System configuration

System configuration includes the following:

- TRDP PD UDP Port: TRDP process data UDP port, if set to 0 it works on the default port 17224;
- Start Command Waiting Seconds: User can set the start command waiting time here to adjust the dynamic configuration time window;
- Ethernet Support DMS: If enabled allows the Ethernet port to support yacer-DMS configuration.

5.2 MVB Configuration

The MVB configuration page is shown below, with the MVB interface and forwarding configuration on the left, and the PD port configuration table on the right.

Interface		MVB	TRDP Receive	TRDP Send
MVB Options (Double-click)	MVB	Address: 10 T_Source: 5BT T_Ignore: 42.7us Medium: EMD Line: Both		
Rx UDP Port		0		
Rx Multicast		0.0.0.0		
Tx Dest IP		0.0.0.0		
Tx UDP Port		0		
PD Acquisition		✘ Disable		
MVB Read-Only		✘ Disable		

	PD Port Type	PD Port	Port Size
1	<input type="radio"/> Sink Port	1000	32 bytes
2	<input checked="" type="radio"/> Source Port	2000	32 bytes
3	✘ Disable	0	2 bytes
4	✘ Disable	0	2 bytes
5	<input checked="" type="radio"/> Source Port	0	2 bytes
6	✘ Disable	0	2 bytes
7	✘ Disable	0	2 bytes
8	✘ Disable	0	2 bytes
9	✘ Disable	0	2 bytes
10	✘ Disable	0	2 bytes

5.2.1 MVB interface configuration

Double-click the cell corresponding to the MVB interface configuration to bring up the MVB parameter configuration dialog.

Device Address:	<input type="text" value="10"/>	0 - 4095
Media Type:	<input type="text" value="EMD"/>	
Line Mode:	<input type="text" value="Line Both"/>	
T_Source:	<input type="text" value="5"/>	BT (1BT = 0.667us)
T_Ignore:	<input type="text" value="0"/>	us (0 = 42.7us)

5.2.1.1 Device address

Users configure device address in the range of 0 to 4095 according to field requirements.

5.2.1.2 Media type

According to the application requirements, users can choose the medium type.

Media Type:	<div style="border: 1px solid black; padding: 2px;"> <div style="background-color: #e6f2ff; padding: 2px;">ESD</div> <div style="background-color: #e6ffe6; padding: 2px;">ESD</div> <div style="background-color: #e6ffe6; padding: 2px;">EMD</div> </div>
-------------	---

5.2.1.3 Line type

Line Mode:	<div style="border: 1px solid black; padding: 2px;"> <div style="background-color: #e6f2ff; padding: 2px;">Line A</div> <div style="background-color: #e6ffe6; padding: 2px;">Line Both</div> <div style="background-color: #e6ffe6; padding: 2px;">Line A</div> <div style="background-color: #e6ffe6; padding: 2px;">Line B</div> </div>
------------	--

Users can choose:

- Line Both: double-line redundancy;
- Line A: A line single line mode;
- Line B: B line single line mode.

5.2.1.4 Other parameters

Using default values, users do not modify or adjust as much as possible.

5.2.2 Ethernet, serial to MVB configuration

When the receive UDP port is 0, MVB-UDP receives data from the host computer through the UART interface and refreshes the time buffer of the PD source port. When the MVB interface receives a process data request from the master station, the MVB-UDP automatically sends a process data response carrying the latest data content.

When the UDP receive port is a legal port number, MVB-UDP receives PD data via Ethernet. If you wish to receive multicast data, you need to set the corresponding receive multicast address.

Rx UDP Port	8000
Rx Multicast	0.0.0.0

5.2.3 MVB to Ethernet, serial configuration

If the forwarding destination IP is a legal unicast, multicast or broadcast address, the PD data of the MVB sink port received by the MVB-UDP is forwarded to the destination IP through the Ethernet port in real time.

If the destination IP is 0, the PD data of the MVB sink port is forwarded to the host computer through the UART interface.

Tx Dest IP	192.168.2.80
Tx UDP Port	8000

5.2.4 PD acquisition

PD acquisition:

- Enable: MVB-UDP receives all PD frames on the MVB bus and forwards them to the host computer;
- Disable: MVB-UDP only receives data from the sink port in the PD port configuration table.

PD Acquisition	<input checked="" type="radio"/> Disable	9	<input checked="" type="radio"/> D
MVB Read-Only	<input checked="" type="radio"/> Disable	10	<input checked="" type="radio"/> D
	<input checked="" type="radio"/> Enable		
	<input checked="" type="radio"/> Disable		

If the MVB Read-only mode is Enable, the MVB-UDP module works in pure receive mode and does not output all frames including device status and PD to the MVB bus.

5.2.5 PD port configuration table

The default version of MVB-UDP supports the configuration of up to 16 process data ports. If users need to configure more PD ports, please contact the manufacturer for customization.

Each PD port entry includes the following parameters:

- PD Port Type: Sink or Source port, Disable means this entry is invalid;
- PD Port Number: Set port number 0 ~ 4095;
- PD Port Size: 2, 4, 8, 16, 32 bytes correspond to 0 ~ 4 of Fcode;

5.3 TRDP Receive Configuration

This page can configure up to 16 TRDP subscription PD entries and the subscribed TRDP PD data is forwarded to the host computer through the UART interface.

Interface		MVB	TRDP Receive	TRDP Send
TRDP PD Subscribe				
	Enable	TRDP Rx COMID	TRDP Rx Multicast	
1	<input checked="" type="radio"/> enable	1001	0.0.0.0	
2	<input checked="" type="radio"/> enable	1002	224.20.20.20	
3	<input checked="" type="radio"/> enable	1003	0.0.0.0	
4	<input checked="" type="radio"/> disable	0	0.0.0.0	
5	<input checked="" type="radio"/> enable	0	0.0.0.0	
6	<input checked="" type="radio"/> disable	0	0.0.0.0	

5.4 TRDP Send Configuration

MVB-UDP receives data from the host computer through the UART interface, refreshes the PD buffer of the TRDP protocol, and then sends PD data periodically according to the PD release configuration, whose destination address can be unicast, multicast or broadcast.

Interface		MVB	TRDP Receive	TRDP Send
TRDP PD Publish				
	Enable	TRDP Tx COMID	TRDP Tx Interval(ms)	TRDP Tx Destination IP
1	<input checked="" type="radio"/> enable	2000	32	192.168.2.80
2	<input checked="" type="radio"/> enable	2001	50	224.10.10.10
3	<input checked="" type="radio"/> enable	2002	16	192.168.2.255
4	<input checked="" type="radio"/> disable	0	0	0.0.0.0
5	<input checked="" type="radio"/> enable	0	0	0.0.0.0
6	<input checked="" type="radio"/> disable	0	0	0.0.0.0

5.5 Firmware Version Upgrade

5.5.1 Start upgrade

Click the “Upgrade” button on the toolbar to pop up the version upgrade dialog, and then click the “Start” button.

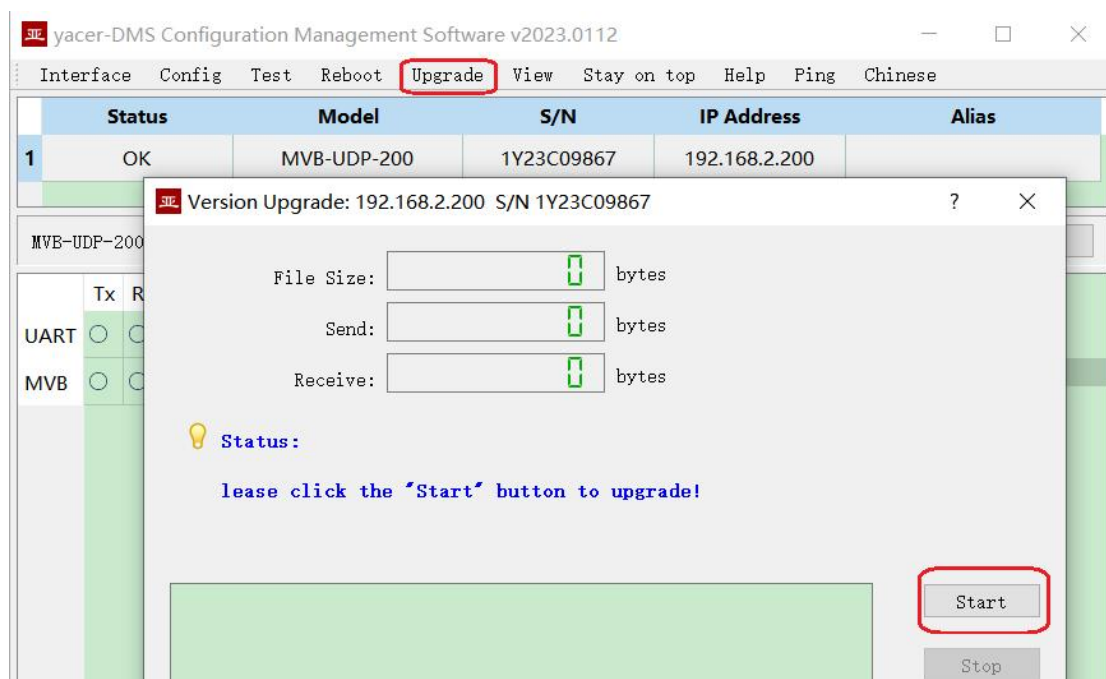

5.5.2 Select version file

Pop up the “Select version file” dialog, and find the folder where the latest firmware version is stored, select the corresponding file, and click “Open” to start the update.

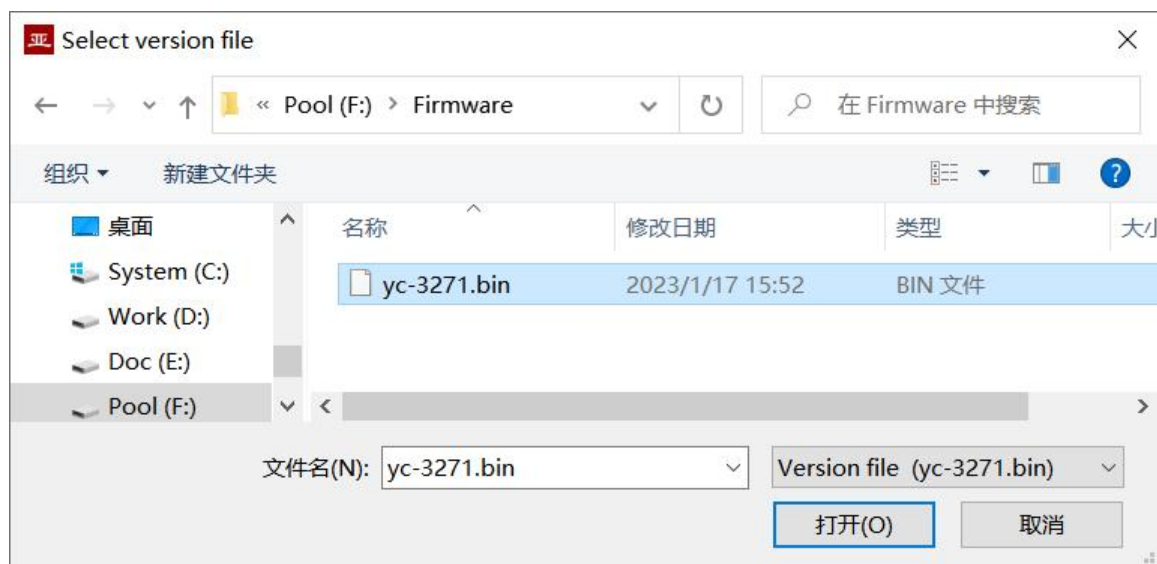

5.5.3 Complete upgrade

When the page displays “Version upgrade complete” status, it indicates that the version upgrade is completed.

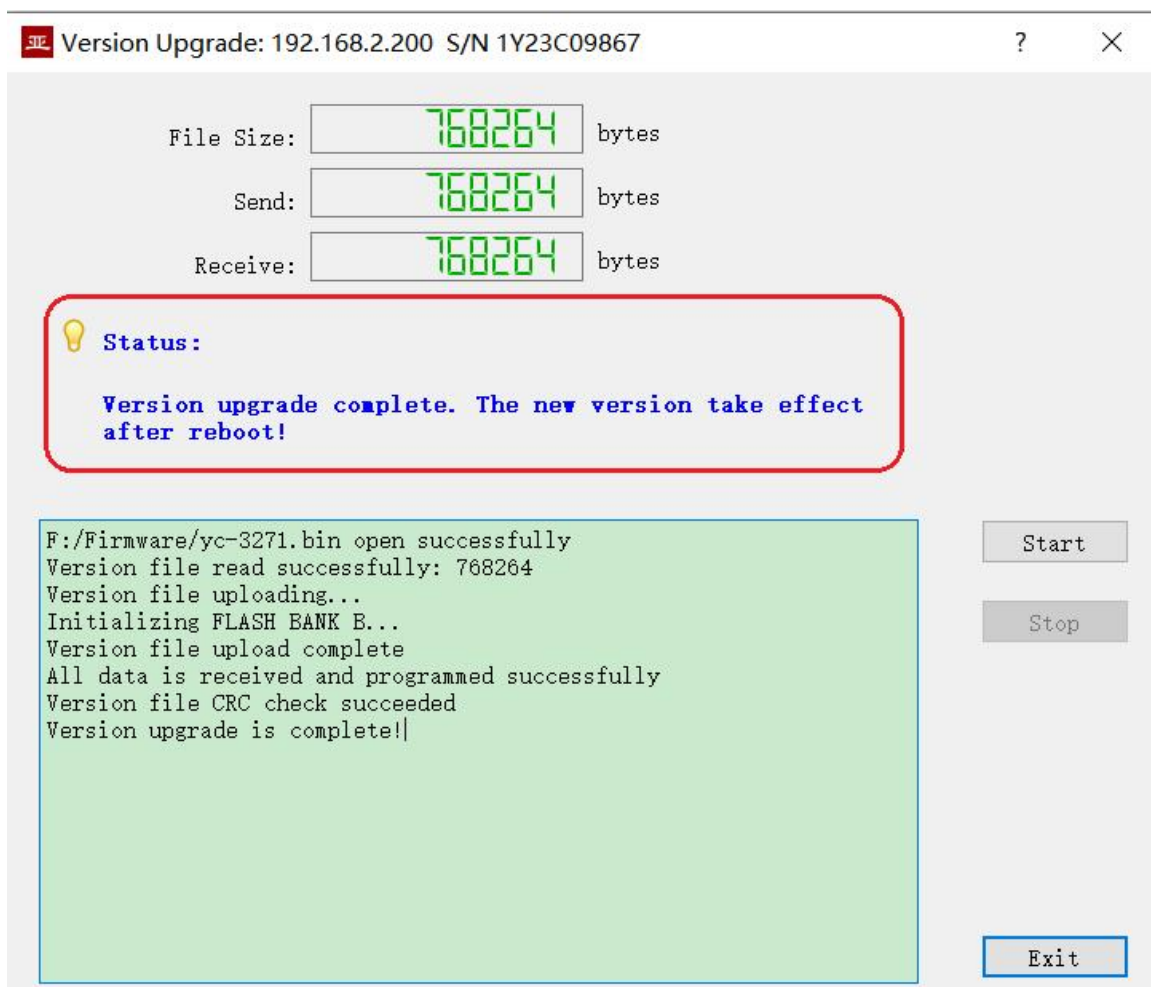

5.5.4 Confirm upgrade

After the upgrade is completed, power up the device again, observe the version information in the statistical report, and determine whether the new version is successfully updated by the version date.



5.6 Reboot Device

Click the “Reboot” button on the toolbar to pop up the device reboot dialog, and then click the “Reboot” button to reboot the device.

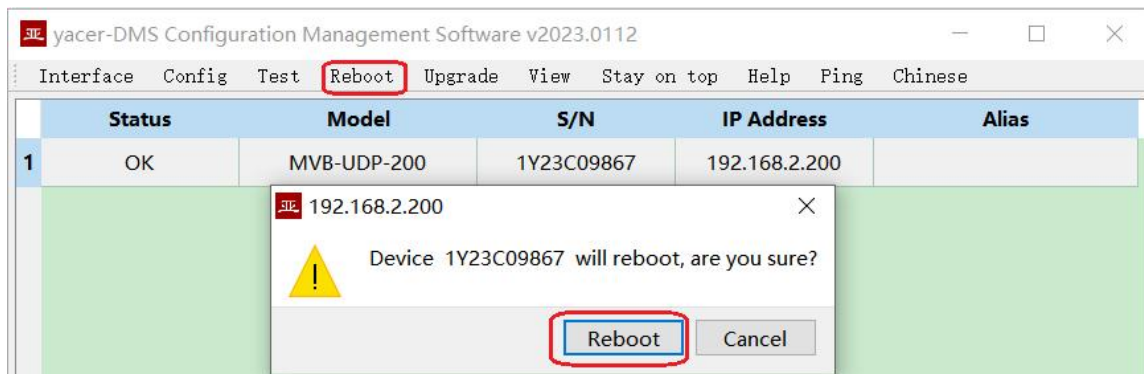

5.7 Ping

By clicking the "Ping" button on the toolbar, DMS automatically starts the ping command on the selected device to check whether the network connection between the configuration management computer and MVB-UDP is working properly.

Before executing the Ping command, first make sure that the IP addresses of the computer and MVB-UDP are in the same subnet.

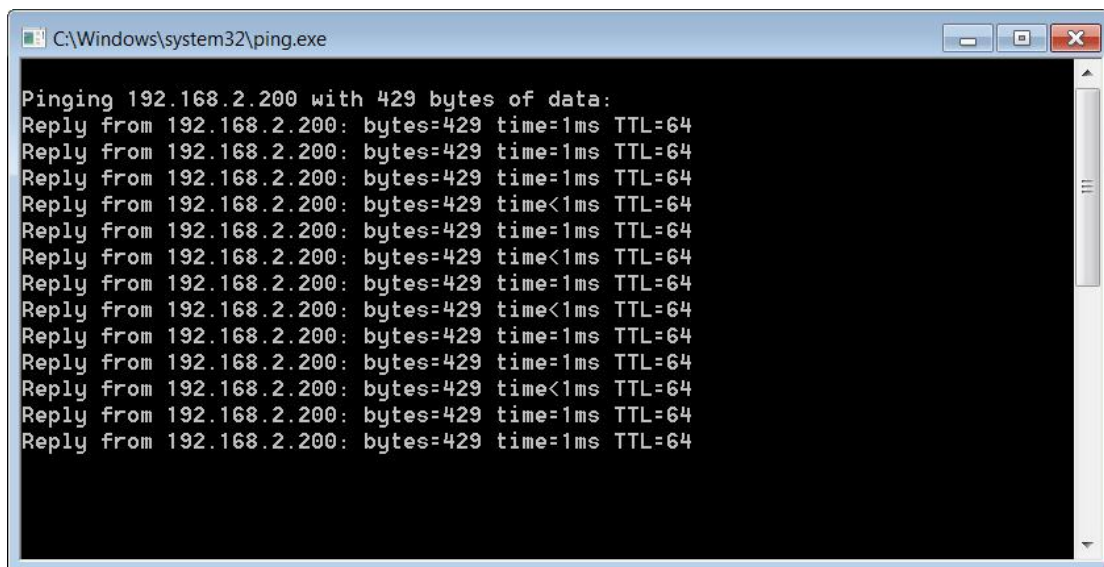

6 Hardware Development

Reference:

- MVB-UDP Hardware Design Guide

7 Software Development

Reference:

- See *TCN-PACKET Programming Manual*.
- See *TCN-UMS Programming Manual*.

UART-PPP protocol implementation C code:

- yacer_uart_ppp.c

About the Manual

- The manual is for reference only. If there is inconsistency between the manual and the actual product, the actual product shall prevail.
- We are not liable for any loss caused by the operations that do not comply with the manual.
- All the designs and software are subject to change without prior written notice. The product updates might cause some differences between the actual product and the manual. Please contact the customer service for the latest program and supplementary documentation.
- There still might be deviation in technical data, functions and operations description, or errors in print. If there is any doubt or dispute, we reserve the right of final explanation.
- Upgrade the reader software or try other mainstream reader software if the manual (in PDF format) cannot be opened.
- Please visit our website, contact the supplier or customer service if there is any problem occurring when using the device.
- If there is any uncertainty or controversy, we reserve the right of final explanation.