

TRDP-CAN-UART

Datasheet

Email: yacer@yacer.cn

Web: www.yacer.com.cn

Foreword

Notational Conventions

The following categorized signal words with defined meaning might appear in the manual.







Signal Words	Meaning
 DANGER	Indicates a high potential hazard which, if not avoided, will result in death or serious injury.
 CAUTION	Indicates a potential risk which, if not avoided, could result in property damage, data loss, lower performance, or unpredictable result.
 ANTISTATIC	Indicates static sensitive equipment.
 DANGER! ELECTRIC SHOCK	Indicates High voltage danger.
 TIPS	Provides methods to help you solve a problem or save you time.
 NOTE	Provides additional information as the emphasis and supplement to the text.

Table of Contents

Foreword	I
1 Overview	IV
1.1 Introduction	IV
1.2 Features	IV
1.3 Applications	IV
1.4 Order Information	IV
1.5 Technical Specifications	V
2 Hardware and Physical Interface	VI
2.1 Appearance	VI
2.2 LED Indicators	VI
2.3 X1: 1x10 2.0mm pitch connector	VI
2.4 X2: 1x10 2.0mm pitch connector	VII
2.5 Mechanical Dimension Drawings	VIII
3 Working State and Initialization	IX
3.1 Working State	IX
3.2 Module Initialization Mode	IX
3.3 Host initialization programming interface	IX
4 yacer-DMS Configuration Management	X
4.1 Get Configuration Management software yacer-DMS	X
4.2 Building Configuration Environment	X
4.2.1 Connect Management Computer to TRDP-CAN-UART	X
4.2.2 Select & Open Configuration Serial Port	X
4.3 Main Window of yacer-DMS	XI
4.4 Statistical Report	XII
4.4.1 Control Panel	XII
4.4.2 Receive & Transmit Indication Panel	XII
4.4.3 Information Panel	XII
4.5 Configure Device	XII
4.6 System Configuration	XIII
4.6.1 Initialization Mode	XIV
4.6.2 Serial Configuration	XIV
4.6.3 CAN Baudrate	XIV
4.6.4 TRDP Forward interface	XIV
4.7 Ethernet Interface Configuration	XIV
4.8 TRDP PD Receive Configuration	XV
4.9 TRDP PD Send Configuration	XV
4.10 Firmware Version Upgrade	XVI
4.10.1 Start Upgrade	XVI
4.10.2 Select Version File	XVI
4.10.3 Complete Upgrade	XVI
4.10.4 Confirm Upgrade	XVII

4.11 Reboot Device	XVII
5 Software Development	XVIII
6 Hardware Development	XIX
6.1 Ethernet Interface Development	XIX
6.1.1 M12 Connector	XIX
6.1.2 Reference Circuit	XIX

1 Overview

1.1 Introduction

The Yacer TRDP-CAN-UART micro embedded NIC module provides one 100M Ethernet PHY interfaces, one UART interface and one CAN interface. Implement protocol conversion between TRDP protocol, serial port or CAN bus.

30x35 mm micro size, 2.0mm pin interface. +3.3V power supply, low power consumption. Industrial wide temperature, suitable for embedded applications.



1.2 Features

- One 10/100M Ethernet PHY, supports TRDP;
- One UART extended serial port;
- One CAN bus interface;
- +3.3V power supply, low power consumption;
- Small size, industrial wide temperature.

1.3 Applications

- Protocol conversion between TRDP and UART;
- Protocol conversion between TRDP and CAN bus interface;
- Train Control and Management System (TCMS);
- Train Communication Network (TCN);
- Embedded application and development.

1.4 Order Information

Model	Ethernet Interface	Extended Interface
TRDP-CU-220	1 x 10/100M PHY	UART + CAN

1.5 Technical Specifications

Item	Parameters	Details
Ethernet Interface	Number	1 x 100M PHY
	Rate	100 Mbps full-duplex
	Protocol	TRDP PD
UART Interface	Level standard	3.3V LVCMOS
	Duplex type	full-duplex, half-duplex
	Baud rate	≤ 921.6 Kbps
CAN Interface	Level standard	3.3V LVCMOS
	Working mode	CAN 2.0A, CAN 2.0B, ISO 11898
	Baud rate	≤ 1 Mbps
Power Requirements	Power Supply	+3.3 VDC
	Power consumption	< 1W
Mechanical Characteristics	Connector	2.0 mm pin connector
	Dimensions	30 mm x 35 mm
	Weight	< 15 g
Operating Environment	Operating temperature	-40 ~ +85°C
	Storage temperature	-40 ~ +85°C
	Operating humidity	5 ~ 95% RH (no condensation)

2 Hardware and Physical Interface

2.1 Appearance

The top and bottom view of TRDP-CAN-UART are as follows, and the signals are drawn out through connector X1 and X2.

X3 is configuration interface used to connect the DMS-UART-8P configuration cable and configure it online through the management computer's USB interface.

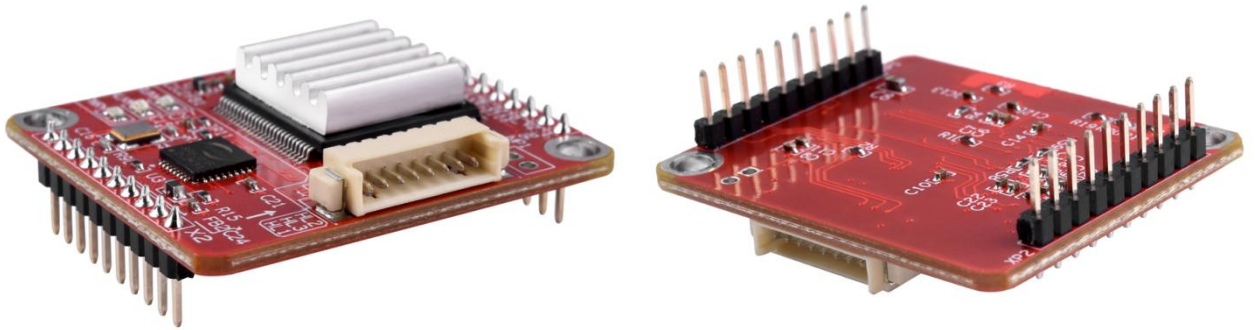

2.2 LED Indicators

LED	Description
RUN	Running indicator, green light flashing during normal operation
ALM	Alarm indicator <ul style="list-style-type: none"> Initialization phase blinking: waiting for the host computer configuration command Normal operation status off: the device is working normally Normal operation status on: device failure
PWR	Power indicator, always on after power on

2.3 X1: 1x10 2.0mm pitch connector

Pin	Name	Type	Description
1	VCC3V3	I	Power input, +3.3VDC
2	RESET_IN	I	Module reset input, active low. Module has POR function, pins can be left floating
3	NC		Standby, must be left floating
4	UART_TxD	O	Serial port data transmit

Pin	Name	Type	Description
5	UART_RxD	I	Serial port data receive
6	UART_TX_EN	O	Serial port transmit enable, active high, for half-duplex
7	NC		Standby, must be left floating
8	NC		Standby, must be left floating
9	NC		Standby, must be left floating
10	GND		Signal ground

2.4 X2: 1x10 2.0mm pitch connector

Pin	Name	Type	Description
1	GND		Signal ground
2	CAN_RX	I	CAN interface data receive
3	CAN_TX	O	CAN interface data transmit
4	NC		Standby, must be left floating
5	ETH_LED	O	Ethernet Link/Act indication, driving LED positive
6	ETH_TX+		Ethernet PHY interface Tx+, external network transformer required
7	ETH_TX-		Ethernet PHY interface Tx-, external network transformer required
8	ETH_RX+		Ethernet PHY interface Rx+, external network transformer required
9	ETH_RX-		Ethernet PHY interface Rx-, external network transformer required
10	GND		Signal ground

2.5 Mechanical Dimension Drawings

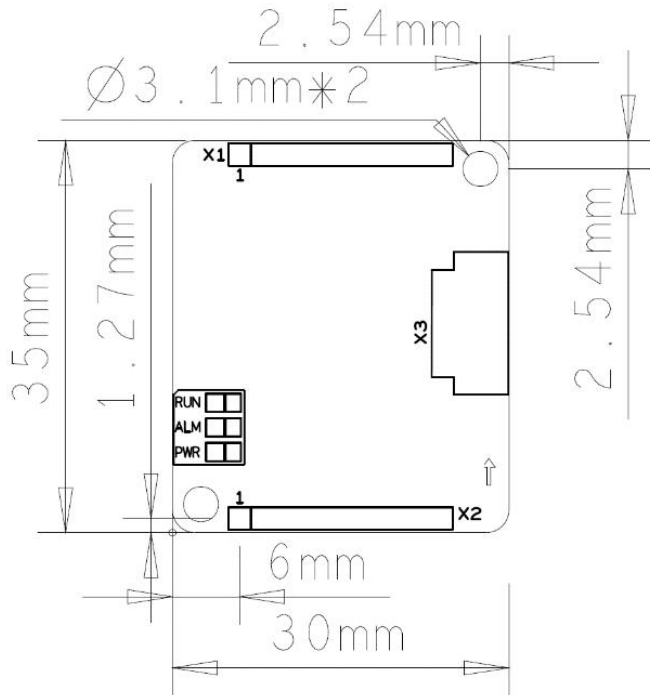

3 Working State and Initialization

3.1 Working State

The TRDP-CAN-UART module has two working states:

- Initialization state: When the module is powered up, it enters the initialization state first, receives or loads the configuration, and performs the system initialization operation.
- Running state: After the module is initialized, it enters the running state and works according to the configuration.

3.2 Module Initialization Mode

The TRDP-CAN-UART module has two initialization methods:

- Host initialization: After the module is powered on, it obtains configuration data from the host through messages and initializes the system. The default initialization mode is Host.
- Local initialization: After the module is powered on, it loads the configuration data from the module's onboard FLASH for initialization.

3.3 Host initialization programming interface

Reference document "THCP Protocol Programming Manual".

4 yacer-DMS Configuration Management

4.1 Get Configuration Management software yacer-DMS

Users can obtain the compressed package yacer-DMS.zip of configuration management software through the following ways:

- “Softwares” directory of TRDP-CAN-UART accompanied U-Disk;
- Official website of Yacer (<http://www.yacer.com.cn>) Software channel.

The yacer-DMS is an installation free application software, unzip yacer-DMS.zip, enter the working directory and double click the file yacer-DMS.exe to run.

4.2 Building Configuration Environment

4.2.1 Connect Management Computer to TRDP-CAN-UART

Connect the special DMS-UART interface (X3) of TRDP-UART to the USB interface of the computer with the DMS-UART-8P configuration cable.

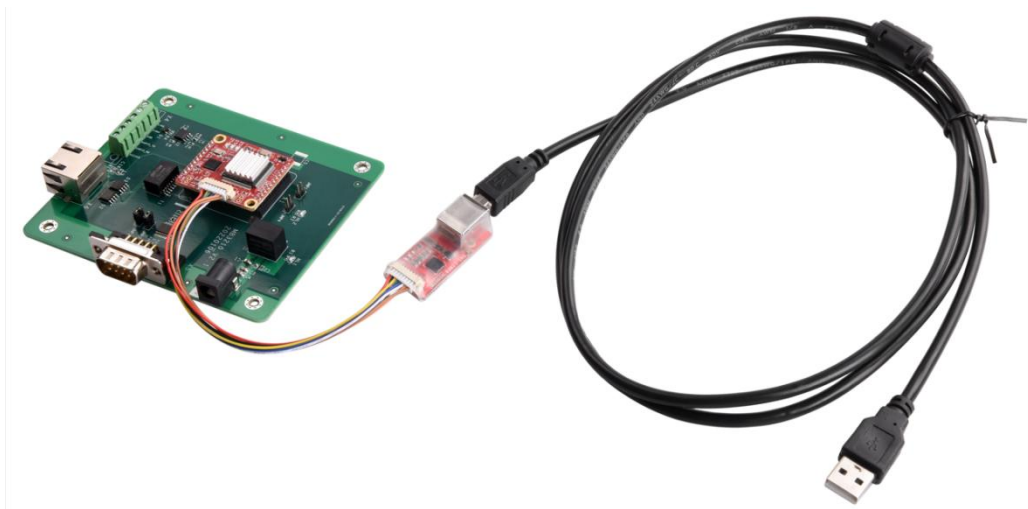

4.2.2 Select & Open Configuration Serial Port

When DMS-UART-8P configuration line is connected to the management computer USB interface, the computer will add a USB simulation serial port.

Click the “Interface” button on the toolbar to pop up the “Host Interface for DMS” configuration dialog. Enter the “Serial” page, select the serial port of the computer connected to TRDP-CAN-UART from the drop-down list, and click “Open Serial” button.

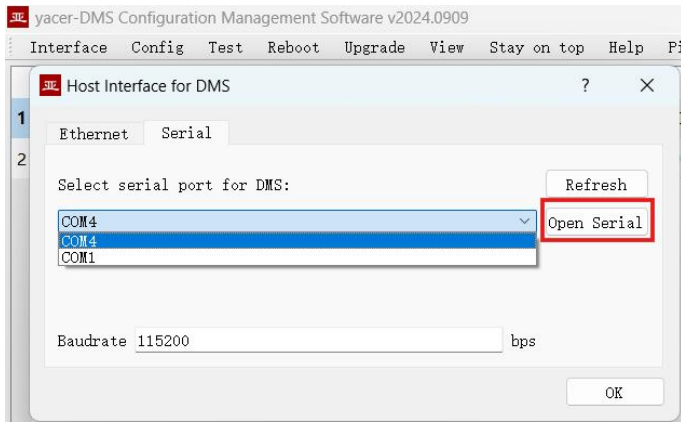

If the serial port is successfully opened, the status is as follows:

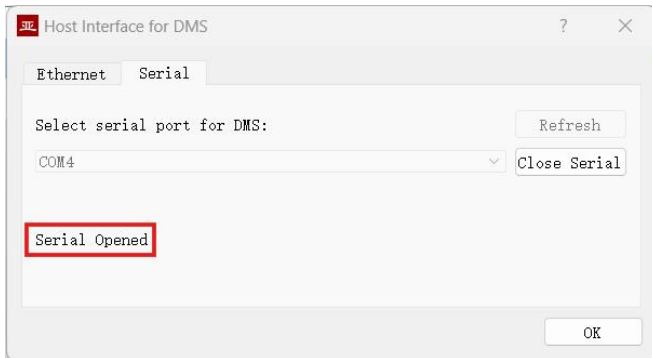

4.3 Main Window of yacer-DMS

The following figure is the main interface of the configuration management software, which can be divided into three parts:

- **Toolbar:** Functional operation buttons;
- **Device List:** Displaying the basic information and operation status of online devices;
- **Statistical Report:** Displaying the receive/transmit indication & statistics, and device details.

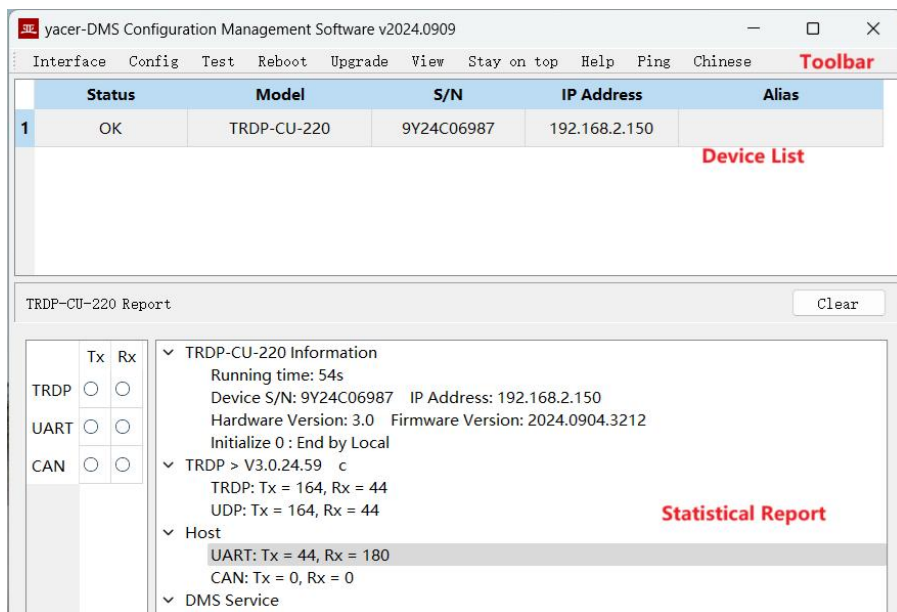

4.4 Statistical Report

The statistical report has three panels: control panel, receive/transmit indication panel and information panel.

4.4.1 Control Panel

Statistical reports are refreshed once per second, and the statistics can be cleared by clicking the "Clear" button.

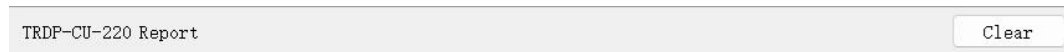

4.4.2 Receive & Transmit Indication Panel

	Tx	Rx
TRDP	<input type="checkbox"/>	<input type="checkbox"/>
UART	<input type="checkbox"/>	<input type="checkbox"/>
CAN	<input type="checkbox"/>	<input type="checkbox"/>

- Tx: The interface sends a frame of data, corresponding Tx indicator blinks once;
- Rx: The interface receives a frame of data, corresponding Rx indicator blinks once.

4.4.3 Information Panel

The right side of the statistical report is the information panel, which can display the following contents:

- Device information: Running time, S/N and Version number;
- TRDP: TRDP protocol transceiver statistics;
- Host: Receive/transmit statistics of UART and CAN ports;
- DMS Service: DMS message receive/transmit statistics.

4.5 Configure Device

Click the 'Config' button on the toolbar or double-click the selected device in the device list, yacer-DMS pops up the configuration dialog. According to the interface and function, the dialog divides the configuration items into several configuration pages.

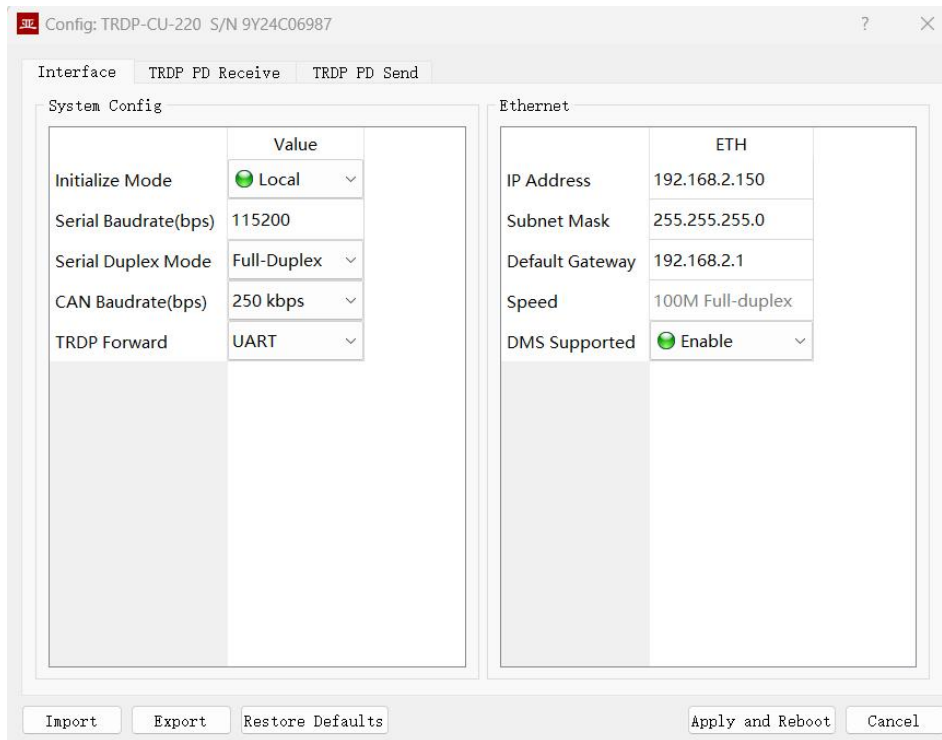

The bottom of the dialog box includes the following operation buttons:

Button	Function
	Open the configuration file, read the configuration parameters refresh the configuration dialog
	Export configuration parameters from the configuration dialog to a file for saving
	Refresh the configuration dialog with the factory paramters
	Write the configuration parameters in the dialog to the device, and restart the device to make the configuration take effect
	Cancel current configuration operation

4.6 System Configuration

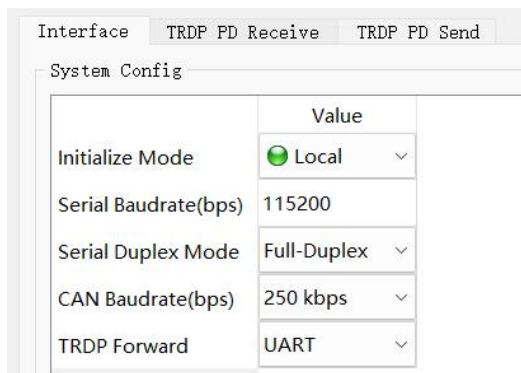

4.6.1 Initialization Mode

Configure the initialization mode for TRDP-CAN-UART module, and the factory default value is Host.

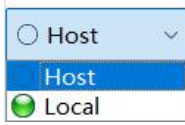

A dropdown menu for selecting the initialization mode. The menu is currently open, showing two options: 'Host' (selected) and 'Local'.

4.6.2 Serial Configuration

Configure the baud rate and duplex mode for serial port. Other serial port parameters are: 8-bit data bit, 1-bit stop bit, and no parity.

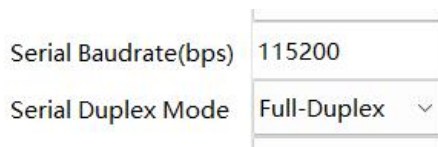

Two input fields for serial configuration. The first field is labeled 'Serial Baudrate(bps)' and contains the value '115200'. The second field is labeled 'Serial Duplex Mode' and contains the value 'Full-Duplex'.

4.6.3 CAN Baudrate

Configure the baud rate for CAN interface.



A dropdown menu for selecting the CAN Baudrate. The menu is currently open, showing the value '250 kbps'.

4.6.4 TRDP Forward interface

This configuration is valid in Local initialization mode.

In Host mode, it indicates the current interface between host and TRDP-CAN-UART module.



A dropdown menu for selecting the TRDP Forward interface. The menu is currently open, showing three options: 'UART' (selected), 'UART', and 'CAN'.

4.7 Ethernet Interface Configuration

Configure the IP address, subnet mask and default gateway for the Ethernet interface here.

Because TRDP runs in the network port, Ethernet is forced to set to 100M full duplex mode.

If enable is selected for DMS supported, yacer-DMS is allowed to configure and manage the TRDP-CAN-UART module through the Ethernet interface.

Ethernet	
ETH	
IP Address	192.168.2.150
Subnet Mask	255.255.255.0
Default Gateway	192.168.2.1
Speed	100M Full-duplex
DMS Supported	<input checked="" type="checkbox"/> Enable

4.8 TRDP PD Receive Configuration

This page can configure up to 16 TRDP subscription PD entries and supporting multicast reception.

Interface		TRDP PD Receive	TRDP PD Send
TRDP PD Subscribe			
	Enable	TRDP Rx COMID	TRDP Rx Multicast
1	<input checked="" type="checkbox"/> Enable	4	224.1.1.5
2	<input checked="" type="checkbox"/> Enable	3	224.1.1.5
3	<input checked="" type="checkbox"/> Enable	0	0.0.0.0
4	<input checked="" type="checkbox"/> Disable	0	0.0.0.0
5	<input checked="" type="checkbox"/> Disable	0	0.0.0.0

4.9 TRDP PD Send Configuration

TRDP-CAN-UART receives data from the host computer through the UART or CAN interface, refreshes the PD buffer of the TRDP protocol, and then sends PD data periodically according to the PD release configuration, whose destination address can be unicast, multicast or broadcast.

Interface		TRDP PD Receive	TRDP PD Send	
TRDP PD Publish				
	Enable	TRDP Tx COMID	TRDP Tx Interval(ms)	TRDP Tx Destination IP
1	<input checked="" type="checkbox"/> Enable	5	300	224.1.2.7
2	<input checked="" type="checkbox"/> Enable	6	300	224.1.3.9
3	<input checked="" type="checkbox"/> Disable	0	0	0.0.0.0
4	<input checked="" type="checkbox"/> Disable	0	0	0.0.0.0
5	<input checked="" type="checkbox"/> Disable	0	0	0.0.0.0

4.10 Firmware Version Upgrade

4.10.1 Start Upgrade

Click the “Upgrade” button on the toolbar to pop up the version upgrade dialog, and then click the “Start” button.

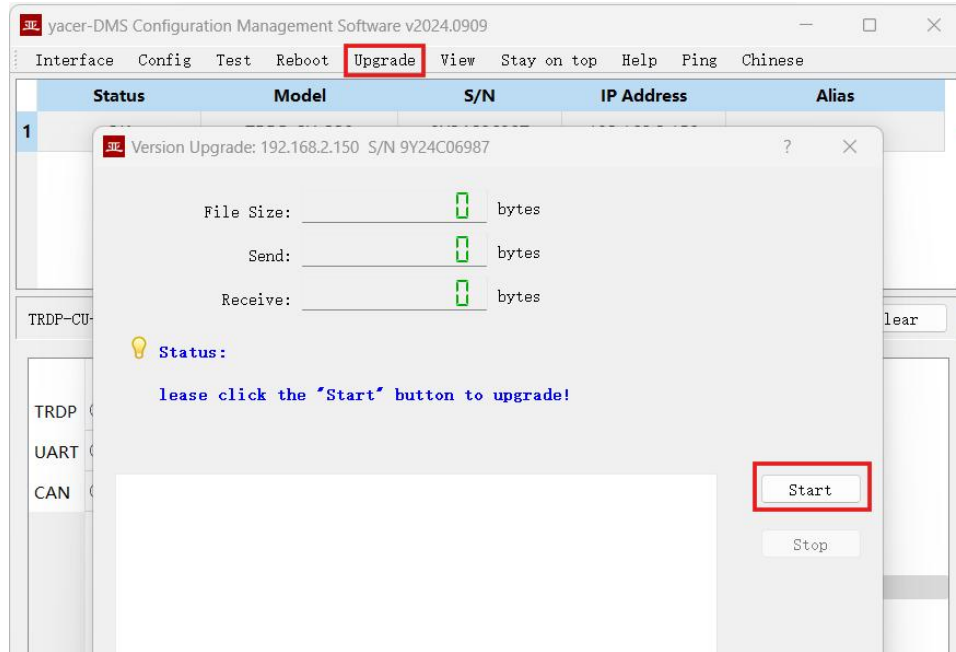

4.10.2 Select Version File

Pop up the “Select version file” dialog, and find the folder where the latest firmware version is stored, select the corresponding file, and click “Open” to start the update.

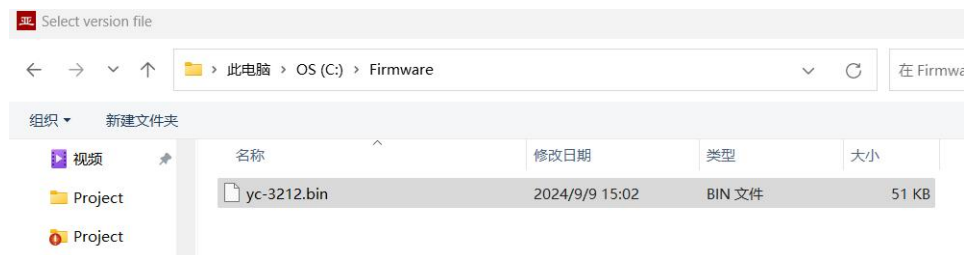

4.10.3 Complete Upgrade

When the page displays “Version upgrade is complete” status, it indicates that the version upgrade is completed.

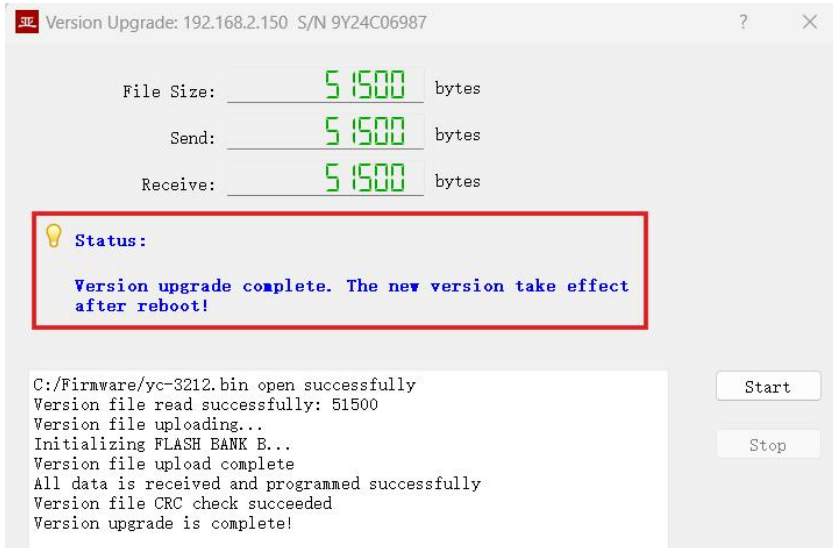

4.10.4 Confirm Upgrade

After the upgrade is completed, power up the device again, observe the version information in the statistical report, and determine whether the new version is successfully updated by the version date.

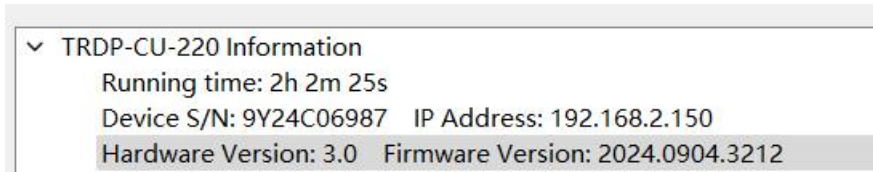

4.11 Reboot Device

Click the “Reboot” button on the toolbar to pop up the device reboot dialog, and then click the “Reboot” button to reboot the device.

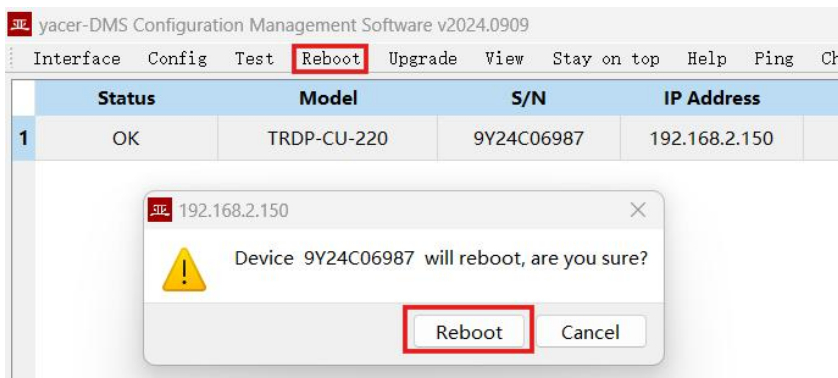

5 Software Development

Reference:

- *THCP Protocol Programming Manual*

UART-PPP protocol implementation C code:

- `yacer_uart_ppp.c`

THCP references C code:

- `thcp_inc.h`
- `thcp_canInc.h`
- `thcp_can.c`: The THCP protocol CAN translates the code

6 Hardware Development

6.1 Ethernet Interface Development

6.1.1 M12 Connector

The train Ethernet interface uses the M12 connector (D-type coded hole) of IEC 61706-2-101 standard. The socket front view and pins are defined as follows:

Pin	Description
1	TD +
2	RD +
3	TD -
4	RD -

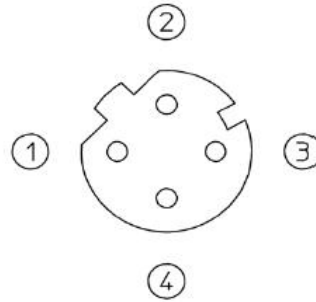

6.1.2 Reference Circuit

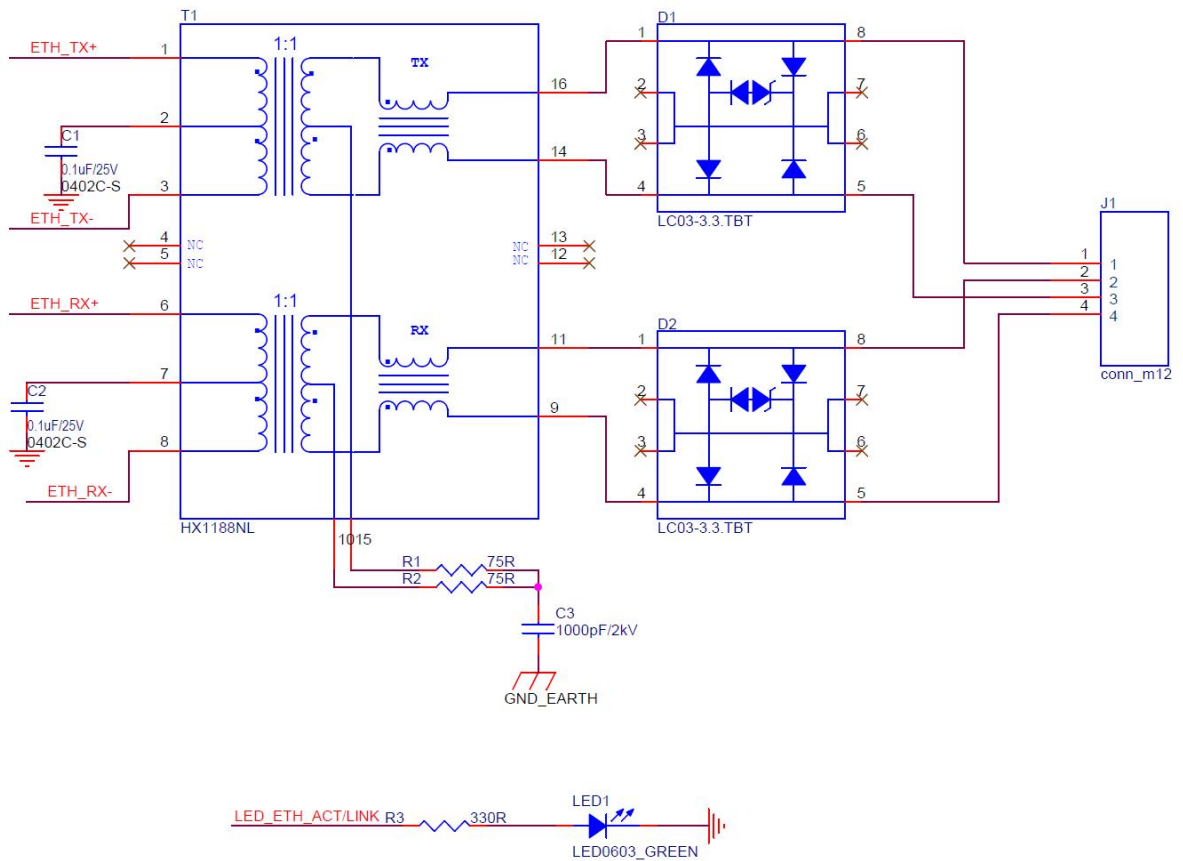

About the Manual

- The manual is for reference only. If there is inconsistency between the manual and the actual product, the actual product shall prevail.
- We are not liable for any loss caused by the operations that do not comply with the manual.
- All the designs and software are subject to change without prior written notice. The product updates might cause some differences between the actual product and the manual. Please contact the customer service for the latest program and supplementary documentation.
- There still might be deviation in technical data, functions and operations description, or errors in print. If there is any doubt or dispute, we reserve the right of final explanation.
- Upgrade the reader software or try other mainstream reader software if the manual (in PDF format) cannot be opened.
- Please visit our website, contact the supplier or customer service if there is any problem occurring when using the device.
- If there is any uncertainty or controversy, we reserve the right of final explanation.