

HDLC-UART

Datasheet

Foreword

Notational Conventions

The following categorized signal words with defined meaning might appear in the manual.







Signal Words	Meaning
 DANGER	Indicates a high potential hazard which, if not avoided, will result in death or serious injury.
 CAUTION	Indicates a potential risk which, if not avoided, could result in property damage, data loss, lower performance, or unpredictable result.
 ANTISTATIC	Indicates static sensitive equipment.
 DANGER! ELECTRIC SHOCK	Indicates High voltage danger.
 TIPS	Provides methods to help you solve a problem or save you time.
 NOTE	Provides additional information as the emphasis and supplement to the text.

Table of Contents

Foreword	I
1 Overview	4
1.1 Introduction	4
1.2 Features	4
1.3 Applications	4
1.4 Order Information	5
1.5 Technical Specifications	5
1.6 Mechanical Data	6
2 Hardware and Physical Interfaces	7
2.1 Appearance	7
2.2 LED Indicators	7
2.3 Pin Definition	8
2.3.1 X1: 1x13 2.54mm pitch connector	8
2.3.2 X2: 1x13 2.54mm pitch connector	9
3 Building Configuration Environment	10
3.1 Connect Management Computer to HDLC-UART	10
3.1.1 Configure with special DMS-UART interface	10
3.2 Get configuration management software yacer-DMS	10
3.3 Run yacer-DMS software	10
3.4 Select & Open Configuration Serial Port	11
3.5 Main Window of yacer-DMS	12
3.6 Statistical Report	12
3.6.1 Control Panel	12
3.6.2 Receive & Transmit Indication Panel	13
3.6.3 Information Panel	13
4 Configuration	14
4.1 Configure Dialog	14
4.2 Baud rate	14
4.3 Interface Configuration	14
4.3.1 Working Mode	14
4.3.2 Encoding format of the HDLC interface	15
4.3.3 HDLC-NRZI Options	16
4.3.4 HDLC-DBPL Options	17
4.3.5 HDLC-DiffMAN (differential Manchester) Options	17
4.3.6 HDLC-MAN (Manchester) Options	18
4.3.7 UART-PPP Options	18
4.3.8 UART Options	19
4.4 Forward Configuration	20
5 Forwarding Function & Data Format	21
5.1 HDLC Interface Data Format	21
5.1.1 HDLC Frame	21

5.2 UART Interface Data Format	21
5.2.1 UART-PACKET Data Packet	21
5.2.2 UART-PPP Frame	22
6 System Maintenance	23
6.1 Firmware Version Upgrade	23
6.1.1 Start Upgrade	23
6.1.2 Select Version File	23
6.1.3 Complete Upgrade	24
6.1.4 Confirm Upgrade	24
6.2 Reboot Device	25

1 Overview

1.1 Introduction

The Yacer HDLC-UART isolate embedded communication module, provides two isolated RS-485/422 Synchronous Serial Port and one UART Extended Interface for protocol conversion between HDLC and UART.

46.5 x 48mm micro size, 2.54 mm pitch male expansion connector. +5V power supply, low power consumption. Industrial wide temperature, suitable for embedded applications.

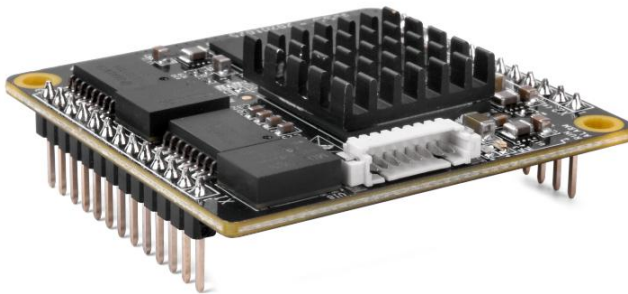

1.2 Features

- Two Isolated RS-485/422 synchronous & asynchronous serial port;
- One CMOS extended synchronous & asynchronous serial port;
- All serial ports support synchronous HDLC and asynchronous UART working mode;
- NRZI, DBPL, Manchester and differential Manchester encoding formats;
- Open and flexible configuration management;
- +5V power supply, low power consumption;
- Small size, Industrial wide temperature.

1.3 Applications

- Protocol conversion between synchronous and asynchronous serial port
- Protocol conversion between HDLC and UART
- Train Control and Management System (TCMS)
- Train Communication Network (TCN)
- Embedded development and application

1.4 Order Information

Model	Description
HDLC-UART-200	2 x Isolated RS-485/422 + 1 x CMOS extended serial port

1.5 Technical Specifications

Item	Parameters	Details
Isolated Synchronous and Asynchronous Serial S1, S2	Interface type	Isolate RS-485/422
	Working mode	Synchronous HDLC, Asynchronous UART
	Encoding format	NRZI, Manchester, Differential Manchester, DBPL(Differential Bi-Phase Level)
	Baud rate	≤ 1 Mbps
	Isolation	2.5 kVrms
CMOS Synchronous and Asynchronous Serial S3	Level standard	3.3V LVCMOS
	Duplex type	full-duplex, half-duplex
	Working mode	synchronous HDLC, asynchronous UART
	Baud rate	≤ 1 Mbps
Configuration Management	Configuration interface	Special DMS-UART interface (by DMS-UART-8P cable)
	Configuration tool	yacer-DMS configuration management software
Power Requirements	Power Supply	+5 VDC
	Power consumption	< 2W
Mechanical Characteristics	Connector	Two 2.54mm pitch 13-pin single-row male connectors
	Dimensions	46.5 x 48 mm
	Weight	15 g
Operating Environment	Operating temperature	-40 ~ +85°C

Item	Parameters	Details
	Storage temperature	-40 ~ +85°C
	Operating humidity	5 ~ 95% RH (no condensation)

1.6 Mechanical Data

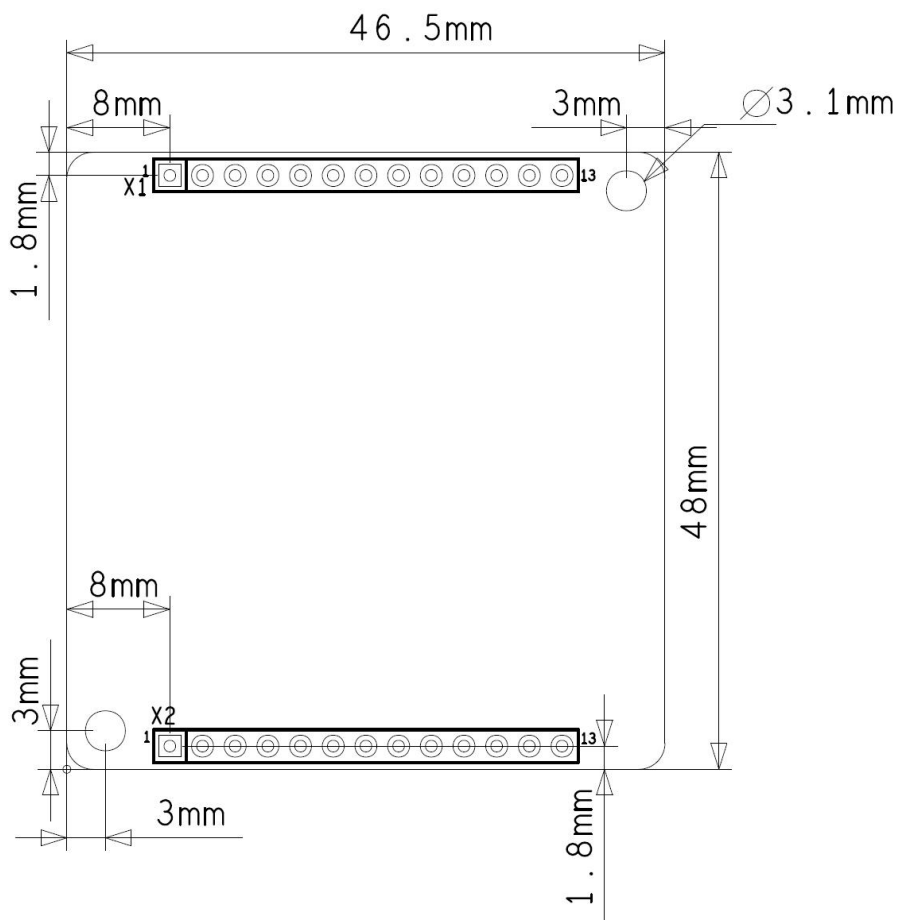

2 Hardware and Physical Interfaces

2.1 Appearance

The top and bottom view of HDLC-UART are as follows, and the signals are drawn out through connector X1 and X2.

X3 is the special DMS-UART configuration interface used to connect the DMS-UART-8P configuration cable and configure it online through the management computer's USB interface.

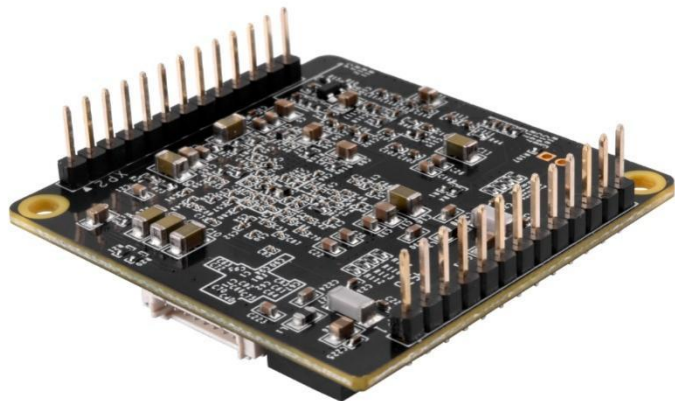
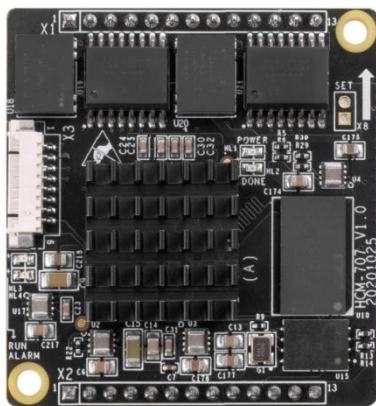

2.2 LED Indicators

Item	Description
RUN	Running indicator, flashing during normal operation
ALARM	Alarm indicator, on when the device is not ready or fails, and off during normal operation
POWER	Power indicator, always on after power on

2.3 Pin Definition

2.3.1 X1: 1x13 2.54mm pitch connector

Pin	Name	Type	Description
1	S1_5V_OUT	O	Isolated serial S1 power out
2	S1_TxD +	O	Positive wire isolated serial S1 transmit
3	S1_TxD -	O	Negative wire isolated Serial S1 transmit
4	S1_RxD +	I	Positive wire isolated serial S1 receive
5	S1_RxD -	I	Negative wire isolated serial S1 receive
6	S1_GND		Ground isolated serial S1
7	NC		Standby, this pin must be left floating
8	S2_5V_OUT	O	Isolated serial S2 power out
9	S2_TxD +	O	Positive wire isolated serial S2 transmit
10	S2_TxD -	O	Negative wire isolated serial S2 transmit
11	S2_RxD +	I	Positive wire isolated serial S2 receive
12	S2_RxD -	I	Negative wire isolated serial S2 receive
13	S2_GND		Ground isolated serial S2

NOTE

- To work in RS-485 half duplex mode, the user must short circuit the serial ports: TXD+ and RXD+, TXD- and RXD-.
- 5V_OUT is +5V DC output, which is only used for bus up-pull and cannot be used for external power supply. Can be hang without use.
- No up, down and matching resistors in HDLC-UART board.

2.3.2 X2: 1x13 2.54mm pitch connector

Pin	Name	Type	Description
1	GND		Logic GND
2	NC		Standby, this pin must be left floating
3	NC		Standby, this pin must be left floating
4	NC		Standby, this pin must be left floating
5	NC		Standby, this pin must be left floating
6	NC		Standby, this pin must be left floating
7	S3_TxEn	O	CMOS serial transmit enable, high-level enable
8	S3_RxD	I	CMOS serial data receive
9	S3_TxD	O	CMOS serial data transmit
10	RESET_IN	I	Module reset, active low. Power-On Reset supported, Pin can be hang.
11	NC		Standby, this pin must be left floating
12	+5V	I	DC +5V Input
13	GND		Logic GND

3 Building Configuration Environment

3.1 Connect Management Computer to HDLC-UART

HDLC-UART provides a variety of configuration management methods to meet different application scenarios.

After the HDLC-UART is configured, the configuration parameters are saved in FLASH on the HDLC-UART board, and will be automatically loaded to work every time HDLC-UART is powered on or restarted in the future.

3.1.1 Configure with special DMS-UART interface

Connect the special DMS-UART interface (X3) of HDLC-UART to the USB interface of the computer with the DMS-UART-8P configuration cable.

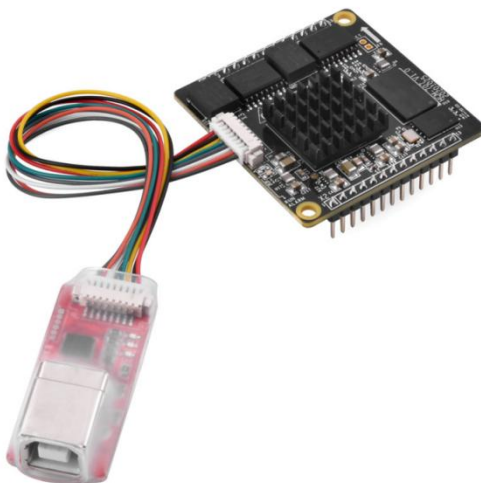

3.2 Get configuration management software yacer-DMS

The user can obtain a compressed package yacer-DMS.zip of configuration management software in the following ways:

- In the “Softwares” directory of the accompanied U disk of HDLC-UART;
- Software channel on the official website (www.yacer.com.cn).

3.3 Run yacer-DMS software

As the free-installation application software, unzip yacer-DMS.zip, enter the working directory and double click the file yacer-DMS.exe to run.

3.4 Select & Open Configuration Serial Port

When DMS-UART-8P configuration line is connected to the management computer USB interface, the computer will add a USB simulation serial port.

Click the “Interface” button on the toolbar to pop up the “Host Interface for DMS” configuration dialog. Enter the “Serial” page, select the serial port of the computer connected to HDLC-UART from the drop-down list, and click “Open Serial” button.

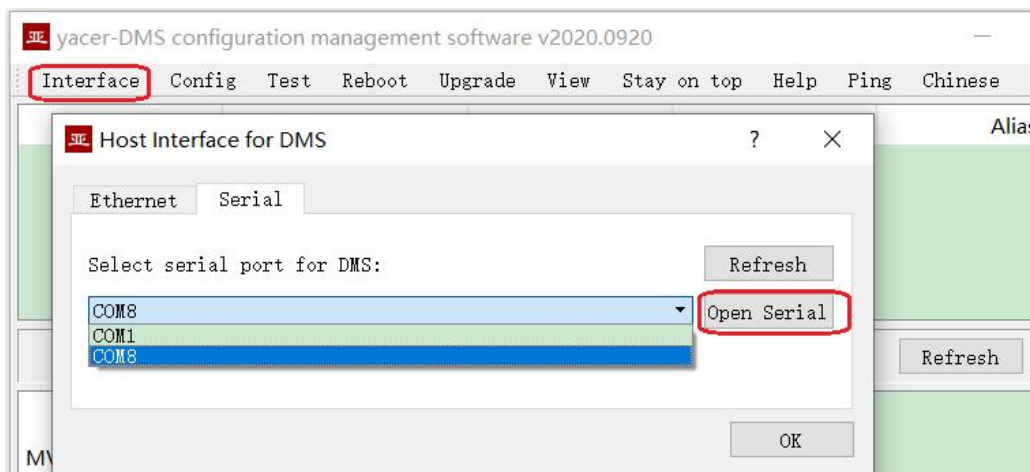

If the serial port is successfully opened, the status is as follows:

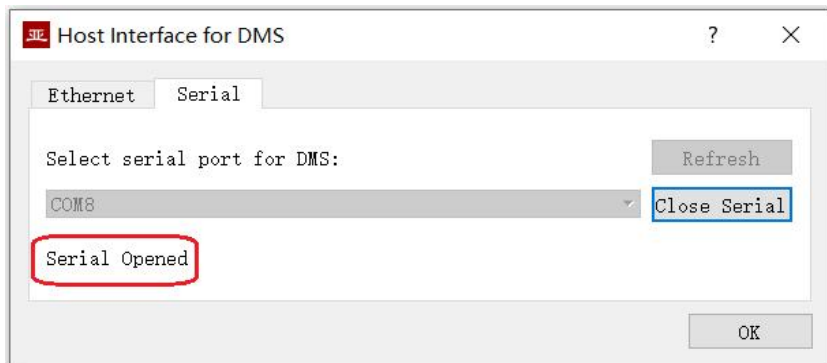

3.5 Main Window of yacer-DMS

The following figure is the main interface of the configuration management software, which can be divided into three parts:

- Toolbar: Functional operation buttons;
- Device List: Displaying the basic information and operation status of online devices;
- Statistical Report: Displaying the receive/transmit indication & statistics, and device details.

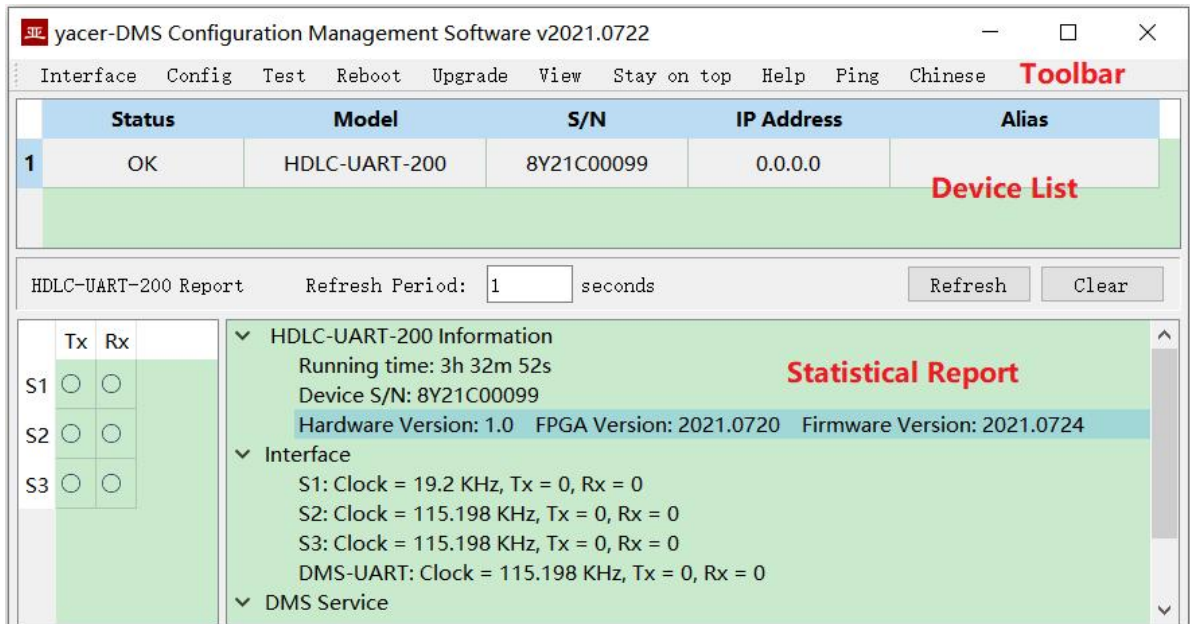

3.6 Statistical Report

The statistical report has three panels: control panel, receive/transmit indication panel and information panel.

3.6.1 Control Panel



Control Widget	Function
Refresh Period: <input type="text" value="1"/> seconds	Statistical report refresh cycle
<input type="button" value="Refresh"/>	Manual refresh operation
<input type="button" value="Clear"/>	Clear the statistical report

3.6.2 Receive & Transmit Indication Panel

- Tx: The interface sends a frame of data, corresponding Tx indicator blinks once;
- Rx: The interface receives a frame of data, corresponding Rx indicator blinks once.

	Tx	Rx	
S1	○	○	
S2	○	○	
S3	○	○	

3.6.3 Information Panel

The right side of the statistical report is the information panel, which can display the following contents:

- Device information: Running time, S/N number, version number;
- Interface: Status and receive/transmit statistics of communication interfaces;
- DMS Service: DMS message receive/transmit statistics.

4 Configuration

4.1 Configure Dialog

Click the main interface button 'device configuration', pop-up configuration dialog box, you can Configure the working mode, parameters, baud rate and forwarding relationship between serial ports of isolated serial ports S1, S2 and extended serial port S3.

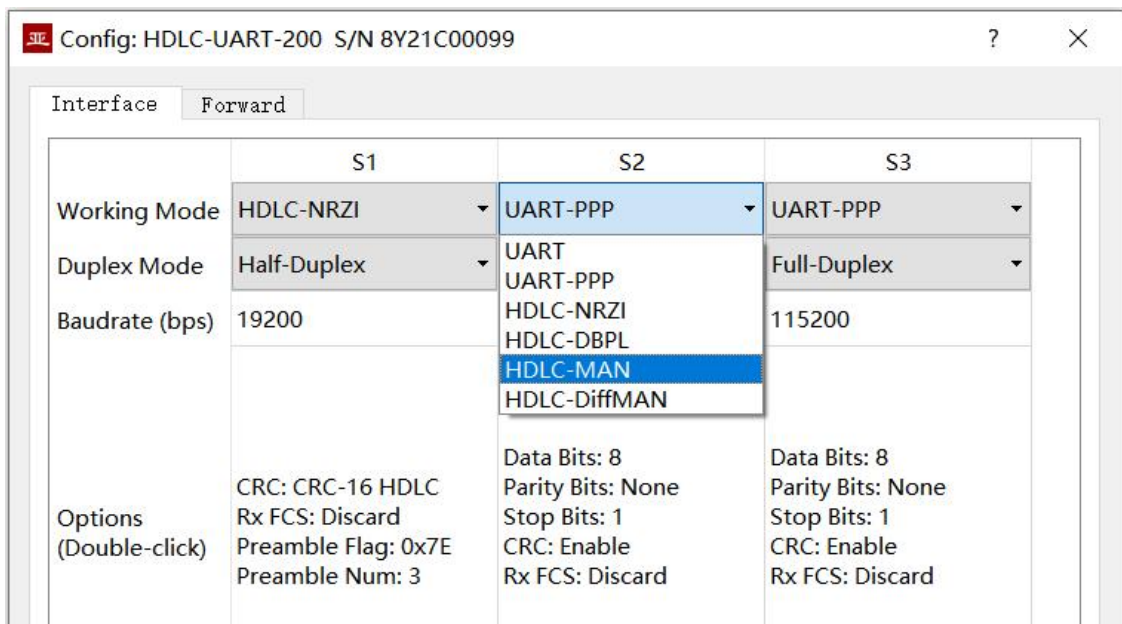

4.2 Baud rate

The baud rate setting of serial port must be exactly the same as the baud rate configuration of the opposite device to ensure reliable and stable data communication.

4.3 Interface Configuration

4.3.1 Working Mode

Serial S1, S2, S3 support the following working modes

Working Mode		Description
Synchronous	HDLC-NRZI	Synchronous HDLC protocol based on the NRZI encoding
	HDLC-DBPL	Synchronous HDLC protocol based on the DBPL (Differential Bi-Phase-Level) encoding

Working Mode		Description
	HDLC-MAN	Synchronous HDLC protocol based on the Manchester encoding
	HDLC-DiffMAN	Synchronous HDLC protocol based on the differential Manchester encoding formats
Asynchronous	UART	Universal asynchronous serial port working mode, equivalent to the serial port on the common computer
	UART-PPP	Frame transmission on UART interface using PPP protocol

Users can select the desired working mode from the “working mode” combo box. Due to different parameter configuration of each working mode, contents of the “Options” cell will be adjusted automatically according to the determined working mode.

If further configuration of working parameters of the selected working mode is required, mouse double-click on the “Options” cell to pop up the parameter configuration dialog.

4.3.2 Encoding format of the HDLC interface

For HDLC-NRZI, HDLC-DBPL, HDLC-MAN, HDLC-DiffMAN and other synchronous working modes, the link layer adopts the HDLC protocol with the encoding format difference as follows:

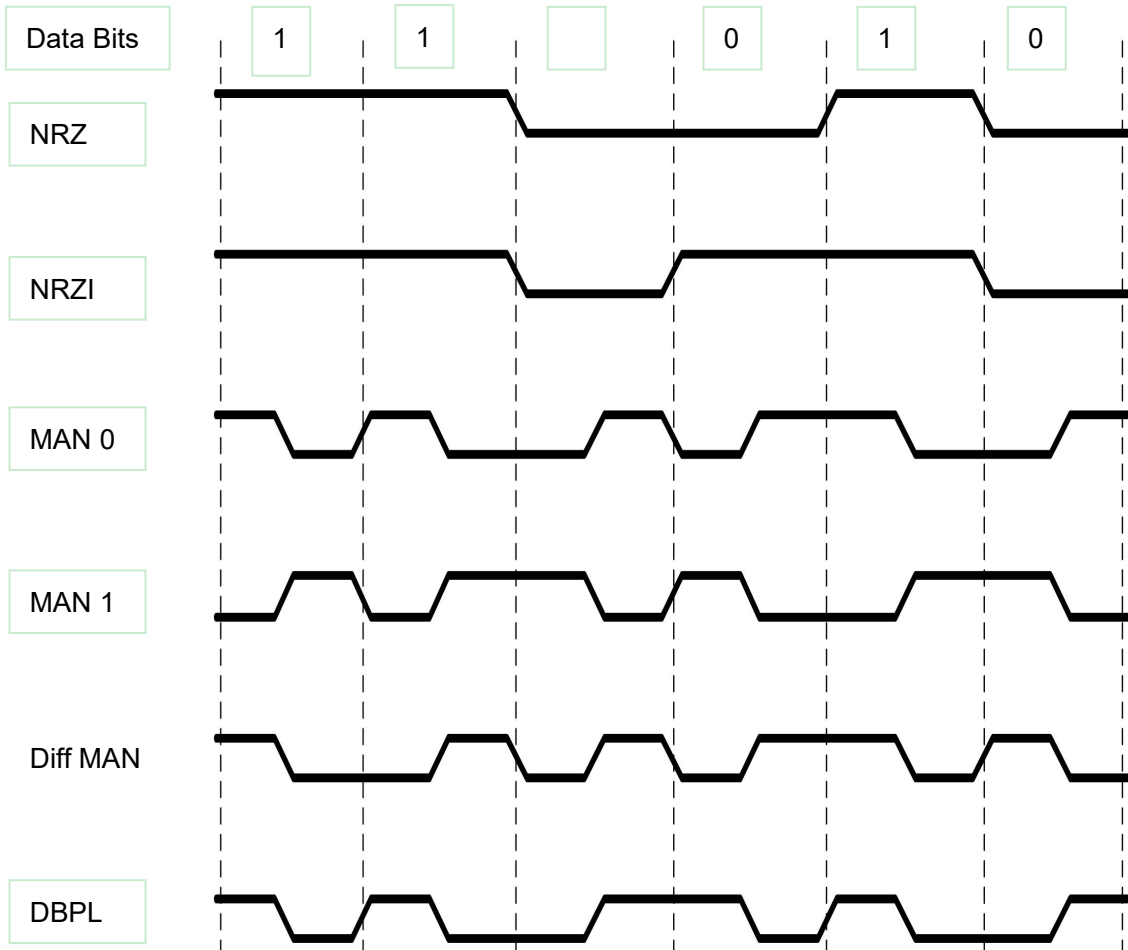

4.3.3 HDLC-NRZI Options

The option dialog of the HDLC-NRZI working mode is shown as follows:

4.3.3.1 CRC

To verify the correctness of data communication, CRC functionality should be enabled. By default, the CRC-16-HDLC check mode should be selected for HDLC communication.

CRC Type	Description
Disable	CRC disable: <ul style="list-style-type: none"> Send: No CRC calculation, no FCS field for HDLC frame Receive: No CRC checking
CRC-16 HDLC	16-bit ISO HDLC CRC verification
CRC-16 SDLC	16-bit IBM SDLC CRC verification

4.3.3.2 Forward received FCS field

This configuration will only take effect if CRC is enabled.

The HDLC frame structure is shown in the following table, where FCS is the frame check sequence field.

Opening Flag	Address Field	Control Field	Information Field	FCS Field	Closing Flag
0x7E	1 Byte	1 Byte	Variable length	CRC 2 bytes	0x7E
0x7E	User Data			CRC 2 bytes	0x7E

If this check box is checked, the user data + FCS field is forwarded.

If this check box is not checked, HDLC-UART, after receiving HDLC frames and performing CRC checks, discards the FCS field of the last 2 bytes of data and forwards only user data.

4.3.3.3 Preamble Flag & Number

In half-duplex communication, it is often necessary to add preamble flags in front of the frame for receiver synchronization. The most common is to add 2-5 0x7E flag.



前导标志: 0x7E

前导个数: 3 字节

0

1

2

3

4

5

6

7

4.3.4 HDLC-DBPL Options

HDLC-DBPL uses the Differential Bi-Phase Level encoding format, and its Options dialog box is shown below:

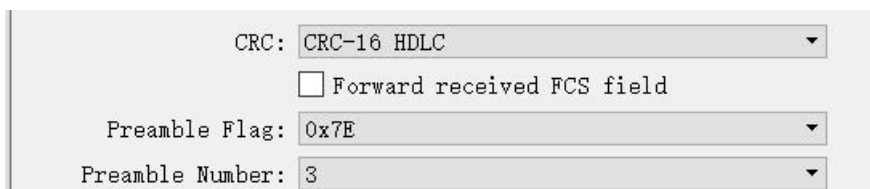

CRC: CRC-16 HDLC

Forward received FCS field

Preamble Flag: 0x7E

Preamble Number: 3

The parameters of HDLC-DBPL have the same meaning as HDLC-NRZI.



NOTE

It is important to note that many claims that DBPL encoding is in fact differential Manchester encoding, so users need to carefully refer to the definition of the Synchronous Serial Encoding Format chapter to choose the correct working mode.

4.3.5 HDLC-DiffMAN (differential Manchester) Options

The Differential Manchester Options dialog box is shown below. The parameters of HDLC-DiffMAN have the same meaning as HDLC-NRZI.

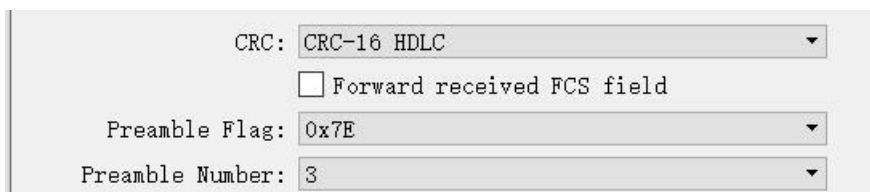

CRC: CRC-16 HDLC

Forward received FCS field

Preamble Flag: 0x7E

Preamble Number: 3

4.3.6 HDLC-MAN (Manchester) Options

HDLC-MAN work mode advanced options dialog box is shown below:

Low to High: 0
 CRC: CRC-16 HDLC
 Forward received FCS field
 Preamble Flag: 0x7E
 Preamble Number: 3

In addition to the same configuration parameters as NRZI, the Manchester encoding format has parameters with the meaning of edges with low to high waveforms for data lines:

- 0: Low to high edges represent logical 0;
- 1: Low to high edges represent logic 1.

Low to High: 0
 0
 1

4.3.7 UART-PPP Options

When the serial port works in the asynchronous UART mode, the serial port sends and receives the character stream without head and tail. In order to transmit a packet, a UART-PPP frame is constructed by adding 0x7E as the start and end marks at the beginning and end of the packet, and inserting a frame check sequence.

Data Bits: 8
 Parity Bits: None
 Stop Bits: 1
 CRC Enable
 Forward received FCS field

4.3.8 UART Options

UART is a type of character stream communication. Data bits, parity bits and stop bits define the basic working parameters of the asynchronous serial port, which must be identical to the configuration of opposite device.

Generally, data bits are defined as 8 bits (1 byte), so that UART corresponds to the communication of byte streams.

Data Bits:	<input type="text" value="8"/>	▼
Parity Bits:	<input type="text" value="None"/>	▼
Stop Bits:	<input type="text" value="1"/>	▼
Rx Packing Size:	<input type="text" value="128"/>	bytes
Rx Packing Interval:	<input type="text" value="10"/>	ms

When converting the byte stream of UART into HDLC frame, if every byte is converted into a frame for transmission, the overhead is too large and the efficiency is too low.

In order to improve the efficiency, HDLC-UART will buffer the received byte stream, and then send out a HDLC frame composed of several buffered bytes. This process is called packing.

Packing is controlled by two parameters, which are called Packing Size & Packing interval.

4.3.8.1 Packing Size

For example, if the Packing Size is set to 128 bytes, then when UART receives 128 bytes, a packet will be formed for forwarding.

Rx Packing Size:	<input type="text" value="128"/>	bytes
------------------	----------------------------------	-------

4.3.8.2 Packing Interval

For example, the above example sets the Packing Interval to 10ms. If the UART does not receive new data after 10ms, the data in the buffer will be forwarded as a packet regardless of whether 128 bytes are received.

Rx Packing Interval:	<input type="text" value="10"/>	ms
----------------------	---------------------------------	----

4.4 Forward Configuration

Forwarding configures the forwarding relationship between serial ports, as shown in the following diagram to achieve bidirectional forwarding between isolated serial port S1, S2 and extended serial port S3.

Interface		Forward			
	Forward	S1 Egress	S2 Egress	S3 Egress	
S1 Ingress	➔ Forward to	<input type="checkbox"/> Enable	<input type="checkbox"/> Enable	<input checked="" type="checkbox"/> Enable	
S2 Ingress	➔ Forward to	<input type="checkbox"/> Enable	<input type="checkbox"/> Enable	<input type="checkbox"/> Enable	
S3 Ingress	➔ Forward to	<input checked="" type="checkbox"/> Enable	<input type="checkbox"/> Enable	<input type="checkbox"/> Enable	

UART-PPP with Tag: 0x5A + serial ID

If "UART-PPP carries Tag" is checked, add 0x5A tag and channel number field (1 byte) before UART-PPP frame. Checking is not recommended for serial port one-to-one forwarding. When two serial inputs are forwarded to a serial port, this option can be checked so that the host computer can obtain the source serial port information.

5 Forwarding Function & Data Format

5.1 HDLC Interface Data Format

5.1.1 HDLC Frame

Synchronous HDLC interface transfers data based on HDLC frames. A complete HDLC frame consists of several fields between the leading flag and the closing flag, including address field, control field, information field and FCS field for CRC check.

For HDLC-UART, instead of distinguishing between address field, control field, and information field, they are uniformly presented as application packets to the upper application to fill in and process the UART packet format.

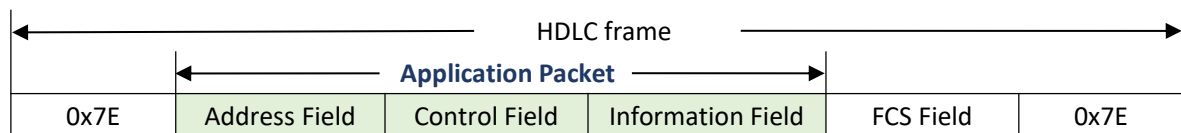

5.2 UART Interface Data Format

5.2.1 UART-PACKET Data Packet

When UART extended interface works in UART mode, there is a character stream without head or tail received from the serial port, where there is no information used to perform unpacking or deframing.

HDLC-UART adopts the time information for unpacking, allowing users to define the packet interval of UART. For example, if the packet interval is 5ms, when no new characters are received over 5ms, then the packet receiving is considered to be complete.

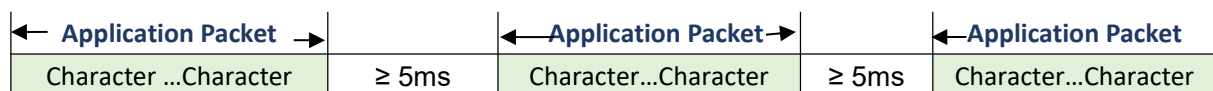

5.2.2 UART-PPP Frame

When the UART extended interface works in UART-PPP mode, another strategy is used to provide the UART with unpacking capability.

First insert two bytes before applying the packet:

- 0x5A: UART-PPP frame identification;
- serial ID: identify the corresponding serial port forwarding channel, 1 for serial port S1, 2 for serial port S2.

Calculates the CRC check value of 0x5A + serial ID + packet, generates a 2-byte FCS frame check field, and then adds 0x7E as the start and end flags to form an UART-PPP frame.

This strategy does not require increasing the additional packet interval and can make full use of the communication bandwidth, but increases the processing complexity of both communication sides.

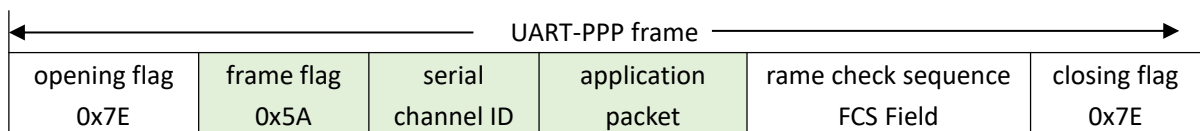

As the application packet and FCS field may appear 0x7E, the sender and receiver shall perform the character escape on the application packet and FCS field with the escape rules as follows:

- 0x7E: Escaped to two characters, 0x7D 0x5E
- 0x7D: Escaped to two characters, 0x7D 0x5D
- Other characters: No escape

The escape operation of data transmit is as follows:

Original Data	Actual Transmit Data
0x7E	0x7D 0x5E
0x7D	0x7D 0x5D
Others	No Change

The escape operation of data transmit is as follows:

Actual Receive Data	Data
0x7D 0x5E	0x7E
0x7D 0x5D	0x7D
Others	No Change

6 System Maintenance

6.1 Firmware Version Upgrade

6.1.1 Start Upgrade

Click the “Upgrade” button on the toolbar to pop up the version upgrade dialog, and then click the “Start” button.

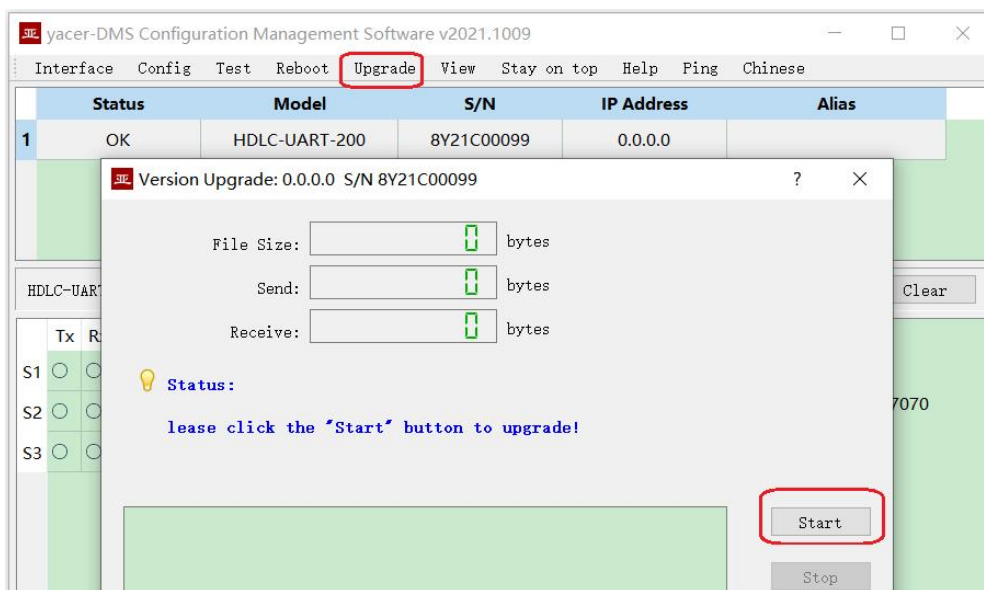

6.1.2 Select Version File

Pop up the “Select version file” dialog, and find the folder where the latest firmware version is stored, select the corresponding file, and click “Open” to start the update.

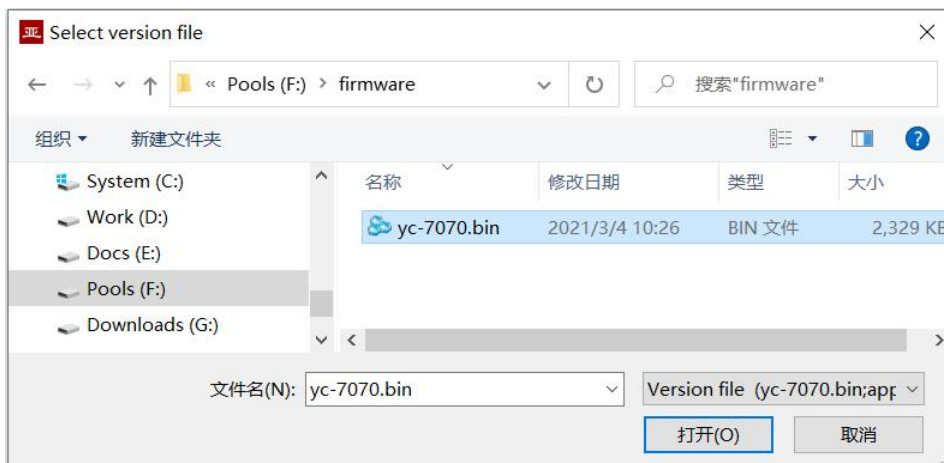

6.1.3 Complete Upgrade

When the page displays “Version upgrade complete” status, it indicates that the version upgrade is completed.

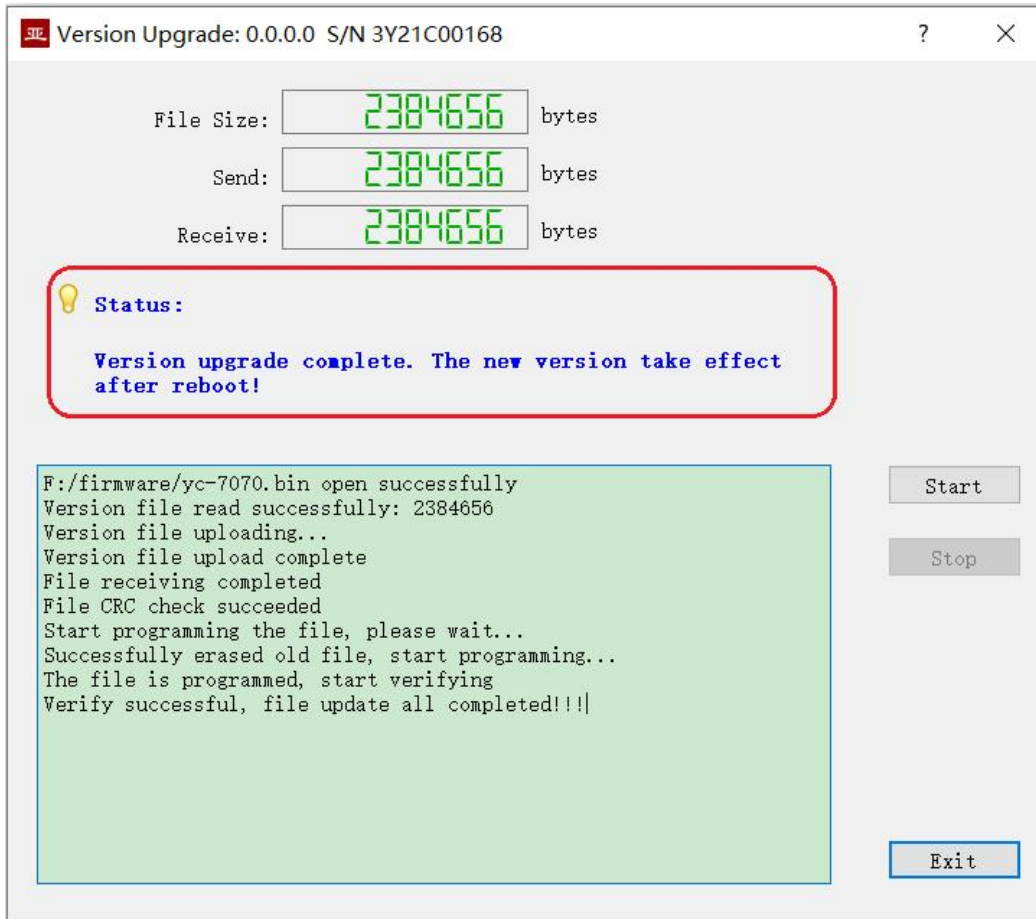

6.1.4 Confirm Upgrade

After the upgrade is completed, power up the device again, observe the version information in the statistical report, and determine whether the new version is successfully updated by the version date.

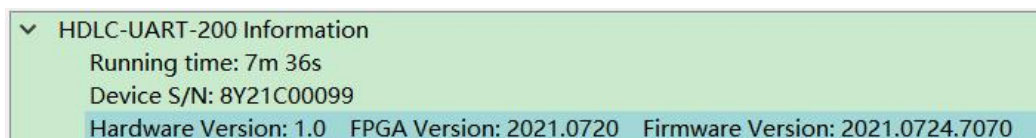

6.2 Reboot Device

Click the “Reboot” button on the toolbar to pop up the device reboot dialog, and then click the “Reboot” button to reboot the device.

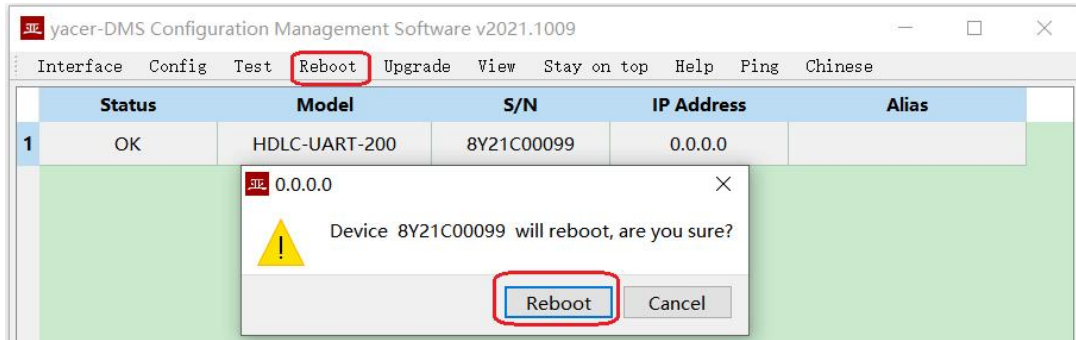

About the Manual

- The manual is for reference only. If there is inconsistency between the manual and the actual product, the actual product shall prevail.
- We are not liable for any loss caused by the operations that do not comply with the manual.
- All the designs and software are subject to change without prior written notice. The product updates might cause some differences between the actual product and the manual. Please contact the customer service for the latest program and supplementary documentation.
- There still might be deviation in technical data, functions and operations description, or errors in print. If there is any doubt or dispute, we reserve the right of final explanation.
- Upgrade the reader software or try other mainstream reader software if the manual (in PDF format) cannot be opened.
- Please visit our website, contact the supplier or customer service if there is any problem occurring when using the device.
- If there is any uncertainty or controversy, we reserve the right of final explanation.