







# MVB-CAN-UART

## Datasheet

# Foreword

## Notational Conventions

The following categorized signal words with defined meaning might appear in the manual.

Signal Words	Meaning
 DANGER	Indicates a high potential hazard which, if not avoided, will result in death or serious injury.
 CAUTION	Indicates a potential risk which, if not avoided, could result in property damage, data loss, lower performance, or unpredictable result.
 ANTISTATIC	Indicates static sensitive equipment.
 DANGER! ELECTRIC SHOCK	Indicates High voltage danger.
 TIPS	Provides methods to help you solve a problem or save you time.
 NOTE	Provides additional information as the emphasis and supplement to the text.

# Table of Contents

<b>Foreword</b> .....	<b>I</b>
<b>1 Overview</b> .....	<b>4</b>
1.1 Introduction .....	4
1.2 Features .....	4
1.3 Applications .....	4
1.4 Order Information .....	5
1.5 Technical Specifications .....	5
1.6 Mechanical Dimension Drawing .....	6
<b>2 Hardware and Physical Interface</b> .....	<b>7</b>
2.1 Appearance .....	7
2.2 LED Indicators .....	7
2.3 Extended Pin Definition .....	7
2.3.1 X1: 1x13 2.54mm pitch connector .....	7
2.3.2 X2: 1x13 2.54mm pitch connector .....	8
<b>3 Application and Development</b> .....	<b>9</b>
3.1 Application Mode .....	9
3.2 Hardware Development .....	9
3.3 Software Development .....	9
3.3.1 Programming Manual .....	9
3.3.2 Reference Code .....	9
<b>4 Working State and Initialization</b> .....	<b>10</b>
4.1 Working State .....	10
4.2 Module Initialization Method .....	10
4.3 Host Initialization Programming Interface .....	10
<b>5 Build Configuration Environment</b> .....	<b>11</b>
5.1 Get Configuration Management Software yacer-DMS .....	11
5.2 Connect Management Computer to MVB-CAN-UART .....	11
5.3 Run yacer-DMS Software .....	11
5.4 Select and Open the Configuration Serial Port .....	11
5.5 Main Window of yacer-DMS .....	12
5.6 Statistical Report .....	13
5.6.1 Control Panel .....	13
5.6.2 Receive/Transmit Indication Panel .....	13
5.6.3 Information Panel .....	14
5.7 Configure Device .....	14
<b>6 Function and Configuration</b> .....	<b>15</b>
6.1 System Configuration .....	15
6.1.1 Initialization Method .....	15
6.1.2 Serial Port Baud Rate .....	15
6.1.3 CAN Baud Rate .....	15
6.1.4 MVB Operating Mode .....	15

---

6.1.5 MVB forwarding interface .....	16
6.2 MVB Configuration .....	16
6.2.1 Device Address .....	16
6.2.2 Media Type .....	17
6.2.3 Line Type .....	17
6.2.4 PD Port Configuration Table .....	17
6.3 Firmware Version Upgrade .....	17
6.3.1 Start Upgrade .....	17
6.3.2 Select Version File .....	18
6.3.3 Complete Upgrade .....	18
6.3.4 Confirm Upgrade .....	19
6.4 Reboot Device .....	19

# 1 Overview

## 1.1 Introduction

The Yacer MVB-CAN-UART isolated embedded slave NIC module provides full-feature MVB redundant interfaces, one UART interface and one CAN bus interface for protocol conversion between MVB and serial port and CAN port.

46.5 x 48 mm small size, 2.54 mm pin connector. + 5V power supply, low power consumption. Industrial wide temperature, suitable for embedded applications.

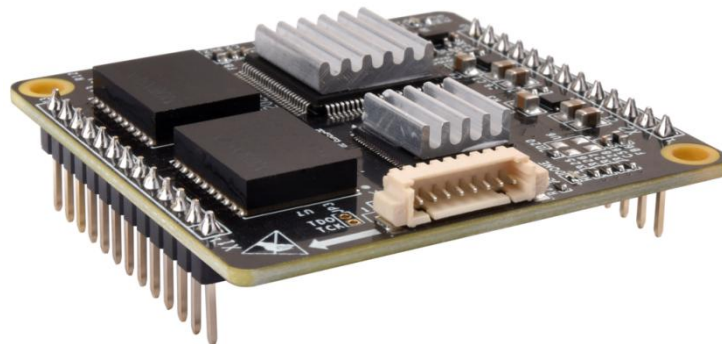

## 1.2 Features

- One full feature MVB redundant interface, compliant with IEC61375 standard;
- Support MVB slave protocol and multiple PD source and sink ports;
- Support MVB bus PD data acquisition function;
- One UART extended serial port, realizing bi-directional conversion between MVB and serial port;
- One CAN bus interface, realizing bi-directional conversion between MVB and CAN;
- + 5V power supply, Low power consumption;
- Small size, Industrial wide temperature.

## 1.3 Applications

- Protocol conversion between MVB and serial port;
- Protocol conversion between MVB and CAN bus;
- Train Control and Management System (TCMS);
- Train Communication Network (TCN);
- Embedded application and development.

## 1.4 Order Information

Model	Description
MVB-CU-300	1 x Dual redundancy MVB + 1 x UART extension + 1 x CAN bus interface

## 1.5 Technical Specifications

Item	Parameters	Details
MVB Interface	Media support	EMD, ESD+
	Device Class	Class 1
	Device Capabilities	Device_Status, Process_Data(PD)
	Number of PD ports	32
	Isolation protection	2.5 kVrms
UART Interface	Level standard	3.3V LVCMOS
	Duplex mode	Full-duplex
	Working mode	Asynchronous UART
	Baud rate	≤ 921.6 Kbps
CAN Interface	Level standard	3.3V LVCMOS
	Working mode	CAN 2.0A、CAN2.0B, ISO 11898
	Baud rate	≤ 1 Mbps
Configuration Management	Configuration interface	Dedicated DMS-UART interface ( with Yacer ' s DMS-UART-8P configuration cable )
	Configuration tool	yacer-DMS configuration management software
Power Requirements	Input voltage	+5V DC
	Power consumption	< 2 W
Mechanical Characteristics	Connector	Two 2.54mm pitch 13 PIN single-row pin connectors
	Dimensions	46.5 mm x 48 mm

Item	Parameters	Details
	Weight	15g
Operating Environment	Operating temperature	-40 ~ +85°C
	Storage temperature	-40 ~ +85°C
	Operating humidity	5 ~ 95% RH (no condensation)



**NOTE:** If you need to support more MVB PD ports, please contact the manufacturer.

## 1.6 Mechanical Dimension Drawing

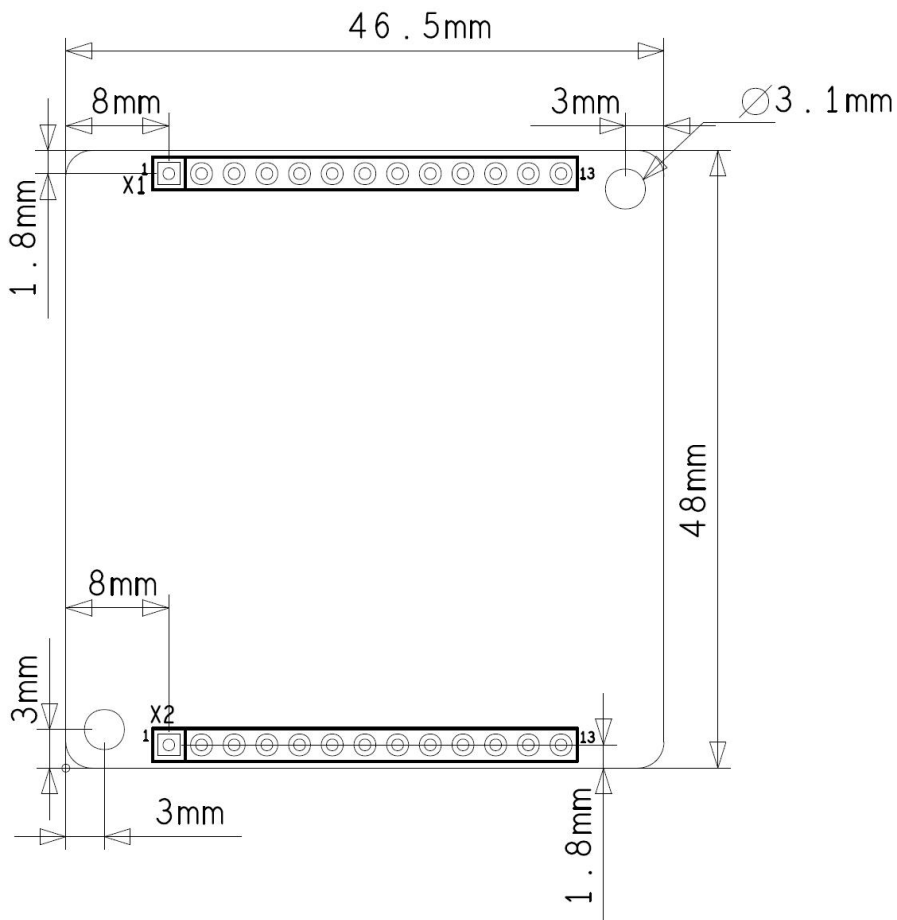

## 2 Hardware and Physical Interface

### 2.1 Appearance

The positive and negative sides of the module are as follows, and the signal is drawn through pin X1, X2.

X3 is the configuration interface, connect the DMS-UART-8P configuration cable, and configure online through the management computer's USB interface.

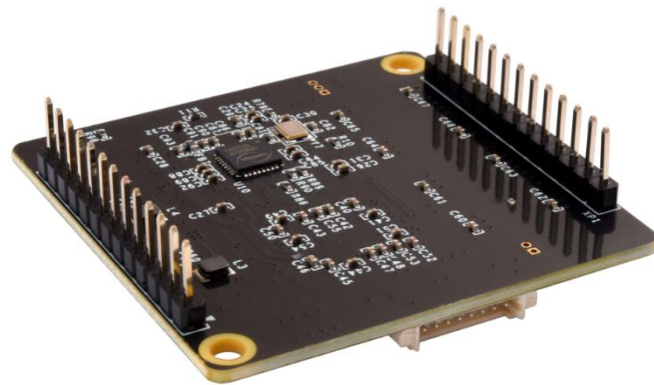
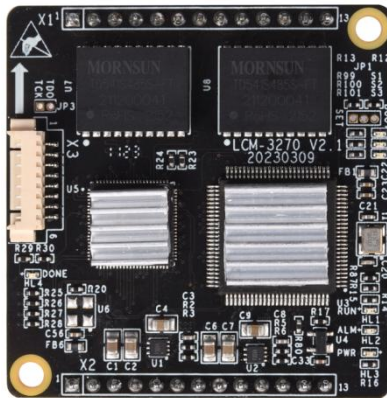

### 2.2 LED Indicators

LED	Description
RUN	Running indicator, green light flashes during normal operation
ALM	Alarm indicator <ul style="list-style-type: none"> <li>Initialization phase blinking: waiting for the host computer configuration command</li> <li>Normal operation status off: the device is working normally</li> <li>Normal operation status on: device failure</li> </ul>
PWR	Power indicator, always on after power on

### 2.3 Extended Pin Definition

#### 2.3.1 X1: 1x13 2.54mm pitch connector

Pin	Signal	Direction	Description
1	MVB_A_5V_OUT	O	MVB interface Line A power output
2	MVB_A_Data +		MVB interface Line A data +
3	MVB_A_Data -		MVB interface Line A data -



Pin	Signal	Direction	Description
4	NC		Standby, this pin must be left floating
5	NC		Standby, this pin must be left floating
6	MVB_A_GND		MVB interface Line A ground
7	NC		Standby, this pin must be left floating
8	MVB_B_5V_OUT	O	MVB interface Line B power output
9	MVB_B_Data +		MVB interface Line B data +
10	MVB_B_Data -		MVB interface Line B data -
11	NC		Standby, this pin must be left floating
12	NC		Standby, this pin must be left floating
13	MVB_B_GND		MVB interface Line B ground

### 2.3.2 X2: 1x13 2.54mm pitch connector

Pin	Signal	Dir	Description
1	GND		Logic ground
2	LED_ALARM	O	System alarm indication, drive LED negative
3	LED_MVB	O	MVB transceiver indication, drive LED negative
4	CAN_RxD	I	CAN interface data reception
5	CAN_TxD	O	CAN interface data transmission
6	LED_HOST	O	UART, CAN transceiver indication, drive LED negative
7	UART_TxEn	O	Serial transmitter enable at UART half-duplex, enable level is high
8	UART_RxD	I	Serial data reception
9	UART_TxD	O	Serial data transmission
10	RESET_IN	I	Module reset input, active low. Module has POR function, pins can be suspended
11	LED_RUN	O	System operation indication, drive LED negative
12	+5V	I	Power input, +5V DC
13	GND		Logic ground

LED Reference Circuit:



## 3 Application and Development

### 3.1 Application Mode

It supports connecting the MVB-CAN-UART module and the host MCU through two modes: UART and CAN. We can choose one of them when developing.

- UART mode

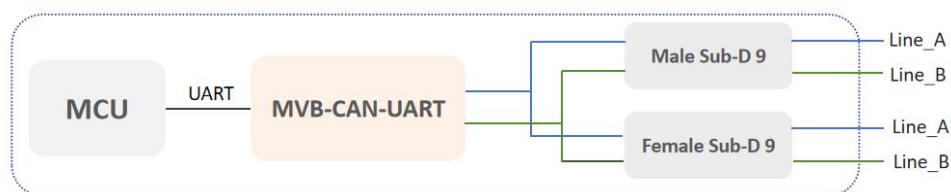

- CAN mode

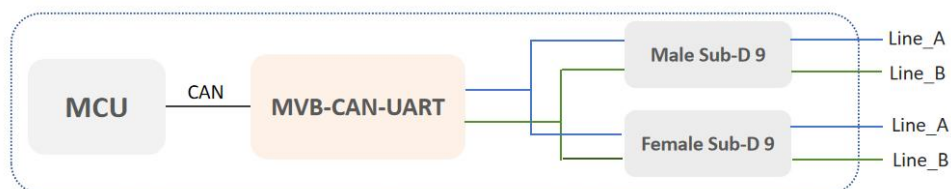

### 3.2 Hardware Development

Reference: *MVB-CAN-UART\_Hardware\_Design\_Guide*

### 3.3 Software Development

#### 3.3.1 Programming Manual

The MVB-CAN-UART module and the host MCU communicate through messages, please refer to '*THCP\_Programming\_Manual*' for details.

#### 3.3.2 Reference Code

UART-PPP protocol implementation C code: `yacer_uart_ppp.c`

Users can obtain THCP references C code from MVB-CAN-UART accompanied U-Disk:

- For Host initialization mode, the reference code directory is "host\_thcp\_example";
- For Local initialization mode, the reference code directory is "local\_thcp\_example".

## 4 Working State and Initialization

### 4.1 Working State

MVB-CAN-UART module has two working states:

- Initialization state: the module enters the initialization state firstly when it starts up, receives or loads the configuration and carries out the system initialization operation;
- Running state: the module enters the running state after initialization, and works according to the configuration.

### 4.2 Module Initialization Method

MVB-CAN-UART module has two initialization methods:

- Host initialization: after the module is powered on, it obtains configuration data from the host computer through messages and carries out system initialization operation. The system default is Host initialization;
- Local initialization: after the module is powered on, load the configuration data in the on-board FLASH of the module for initialization.

### 4.3 Host Initialization Programming Interface

Refer to the document '*THCP\_Programming\_Manual*' .

## 5 Build Configuration Environment

### 5.1 Get Configuration Management Software yacer-DMS

Users can obtain the compressed package yacer-DMS.zip of configuration management software through the following ways:

- “Softwares” directory of MVB-CAN-UART accompanied U-Disk;
- Official website of Yacer (<https://www.yacer.com.cn>) Software channel.

The yacer-DMS is an installation free application software, unzip yacer-DMS.zip, enter the working directory and double click the file yacer-DMS.exe to run.

### 5.2 Connect Management Computer to MVB-CAN-UART

Connect the DMS-UART interface (X3) of MVB-CAN-UART to the USB interface of the computer with the DMS-UART-8P configuration cable.



### 5.3 Run yacer-DMS Software

The yacer-DMS is an installation free application software, unzip yacer-DMS.zip, enter the working directory and double click the file yacer-DMS.exe to run.

### 5.4 Select and Open the Configuration Serial Port

When the DMS-UART-8P configuration cable is connected to the USB interface of the management computer, the computer adds a USB emulation serial port.

Click the 'Interface' button on the yacer-DMS toolbar to pop up the “Host Interface for DMS” configuration dialog. Enter the “Serial” page, select the USB simulation serial port or other serial ports involved in the configuration from the drop-down list, click “Open Serial”.

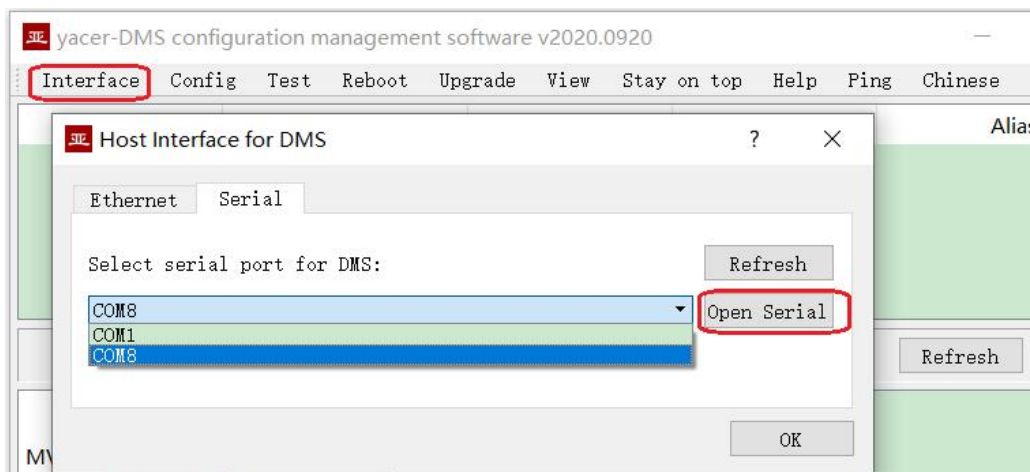

If the serial port is successfully opened, the state is as follows:

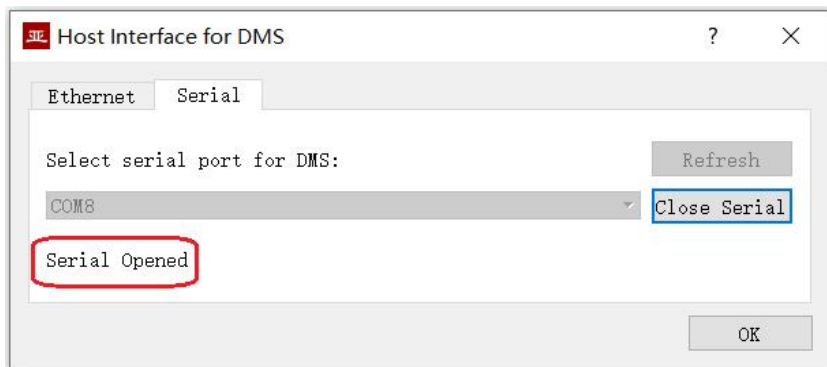

## 5.5 Main Window of yacer-DMS

The following figure is the main interface of the configuration management software, which can be divided into three parts:

- Toolbar: Functional operation buttons;
- Device List: Displaying the basic information and operation status of online devices;
- Statistical Report: Displaying the receive/transmit indication & statistics, and device details.

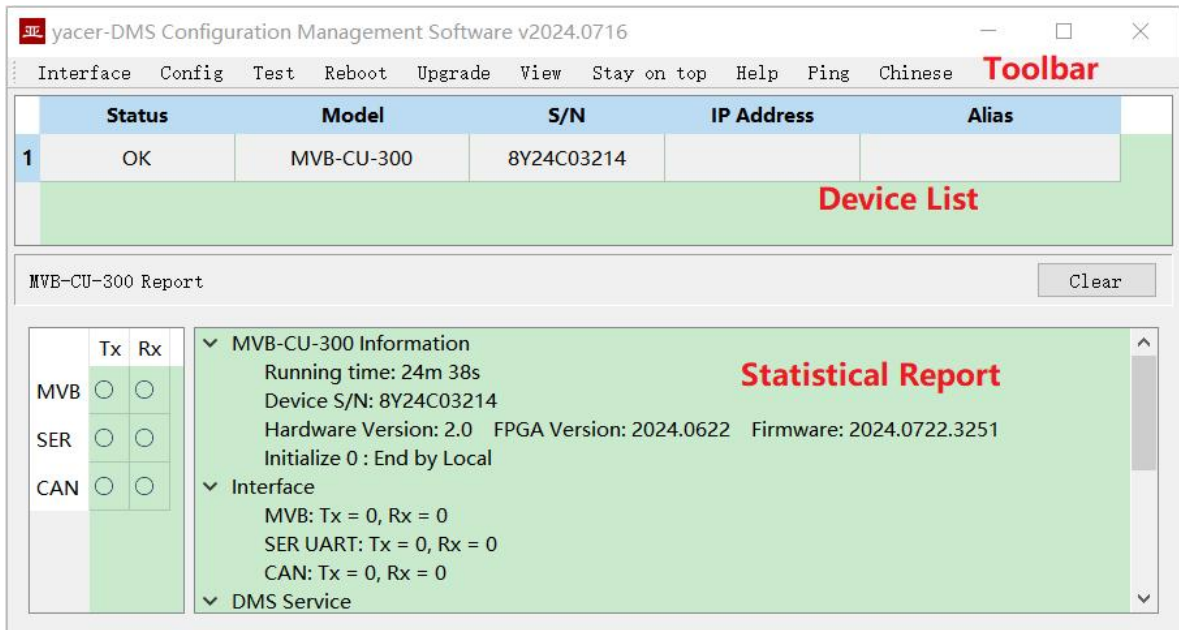

## 5.6 Statistical Report

The statistical report has three panels: control panel, receive/transmit indication panel and information panel.

### 5.6.1 Control Panel

Statistical report data is refreshed once per second and can be cleared by clicking the “Clear” button.



### 5.6.2 Receive/Transmit Indication Panel

- Tx: The interface sends a frame of data, corresponding Tx indicator blinks once;
- Rx: The interface receives a frame of data, corresponding Rx indicator blinks once.

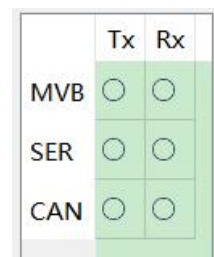

### 5.6.3 Information Panel

The right side of the statistical report is the information panel, which can display the following contents:

- Device information: Running time, S/N number, version number;
- Interface: Receive/transmit statistics of MVB, UART and CAN interface;
- DMS Service: Configuration management message receive/transmit statistics.

## 5.7 Configure Device

Click the “Config” button on the toolbar or double-click the selected device in the device list, yacer-DMS pops up the configuration dialog.

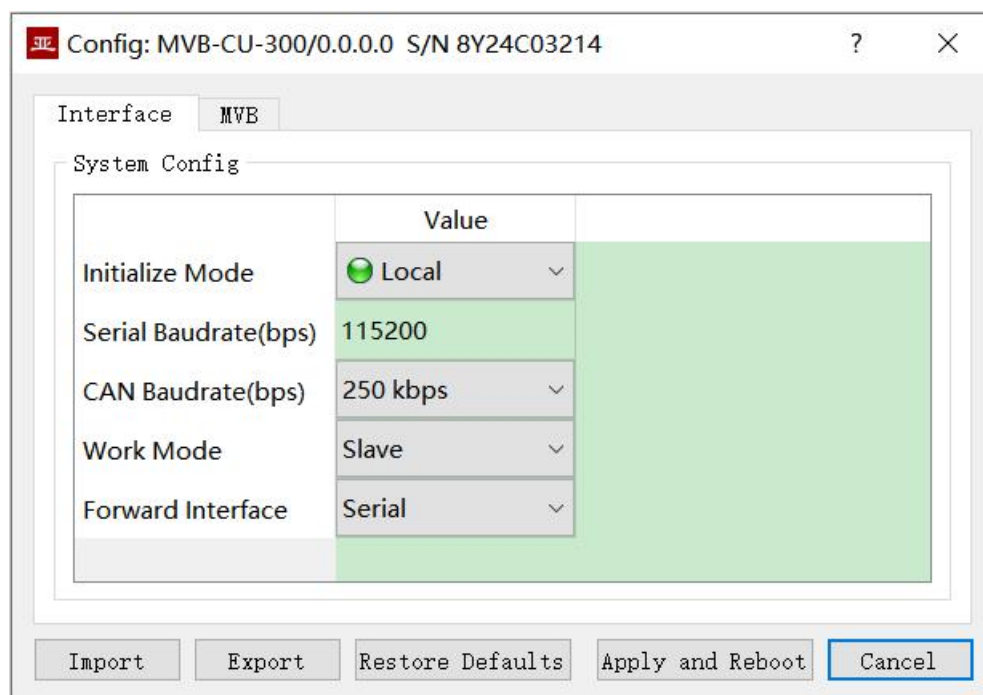

The bottom of the dialog box includes the following operation buttons:

Button	Function
Import	Open the configuration file, read the configuration parameters refresh the configuration dialog
Export	Export configuration parameters from the configuration dialog to a file for saving
Restore Defaults	Refresh the configuration dialog with the factory paramters
Apply and Reboot	Write the configuration parameters in the dialog to the device, and restart the device to make the configuration take effect
Cancel	Cancel current configuration operation

## 6 Function and Configuration

### 6.1 System Configuration

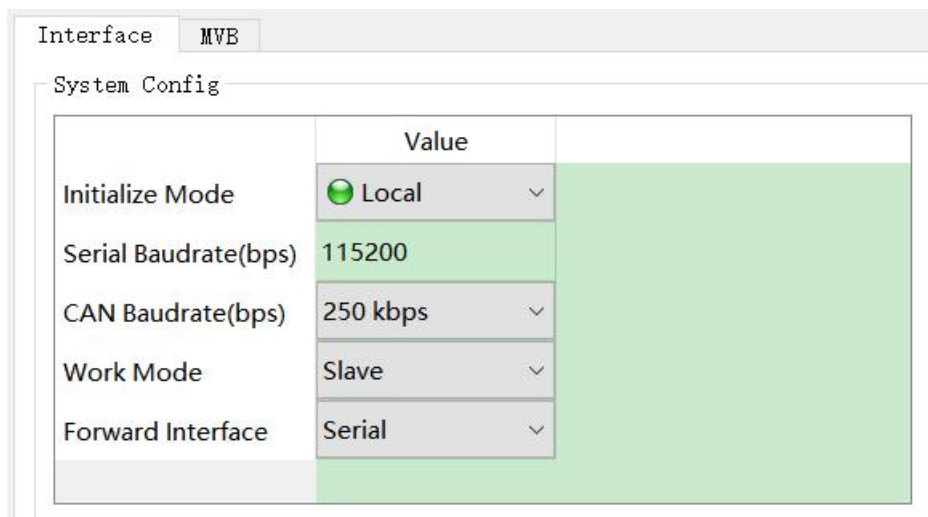

#### 6.1.1 Initialization Method

Configure the initialization method of the module, the factory default is Host method.



#### 6.1.2 Serial Port Baud Rate

Configure the serial port baud rate.

Other serial port parameters are: data bit 8bit, stop bit 1bit, no parity.

#### 6.1.3 CAN Baud Rate

CAN bus interface baud rate.

#### 6.1.4 MVB Operating Mode

Module MVB has two modes of operation:

- Slave mode: MVB slave PD bidirectional communication mode;



- Acquisition Mode: Receive all PD data from the MVB bus. The module works in pure reception mode and will not output all frames including device status and PD to the MVB bus.

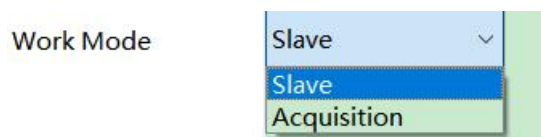

## 6.1.5 MVB forwarding interface

Local Initialization Mode This configuration is valid.

Host mode indicates the current host interface.

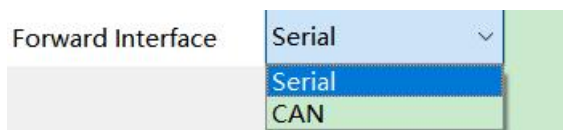

## 6.2 MVB Configuration

The MVB configuration page is shown below, with the MVB interface and forwarding configuration on the left, and the PD port configuration table on the right.

In Local initialization mode, the module initializes the MVB interface with this configuration.

In Host initialization mode, this page shows the configuration parameters from the host computer.

Interface		MVB	PD Port Configuration			
Device Address	10		1	<input checked="" type="radio"/> Source Port	1000	32 bytes
Media Type	EMD		2	<input type="radio"/> Sink Port	2000	32 bytes
Line Mode	Line Both		3	<input checked="" type="radio"/> Disable	0	2 bytes
			4	<input checked="" type="radio"/> Disable	0	2 bytes
			5	<input checked="" type="radio"/> Source Port	0	2 bytes
			6	<input checked="" type="radio"/> Disable	0	2 bytes

### 6.2.1 Device Address

Users configure device address in the range of 0 to 4095 according to field requirements.

## 6.2.2 Media Type

According to the application requirements, users can choose the medium type.

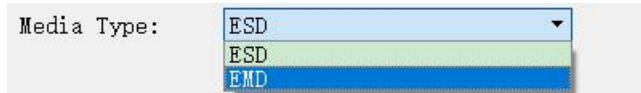

## 6.2.3 Line Type

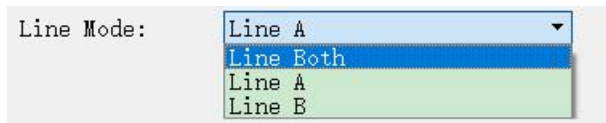

Users can choose:

- Line Both: Dual-line redundancy;
- Line A: Line A single line mode;
- Line B: Line B single line mode.

## 6.2.4 PD Port Configuration Table

The default version of the MVB-CAN-UART supports up to 32 process data ports with the following parameters included for each PD port item:

- PD Port Type: Sink or Source port, disable means this entry is invalid;
- PD Port: Set port number 0 ~ 4095;
- Port Size: 2, 4, 8, 16, 32 bytes correspond to 0 ~ 4 of fcode;

## 6.3 Firmware Version Upgrade

### 6.3.1 Start Upgrade

Click the “Upgrade” button on the toolbar to pop up the version upgrade dialog, and then click the “Start” button.

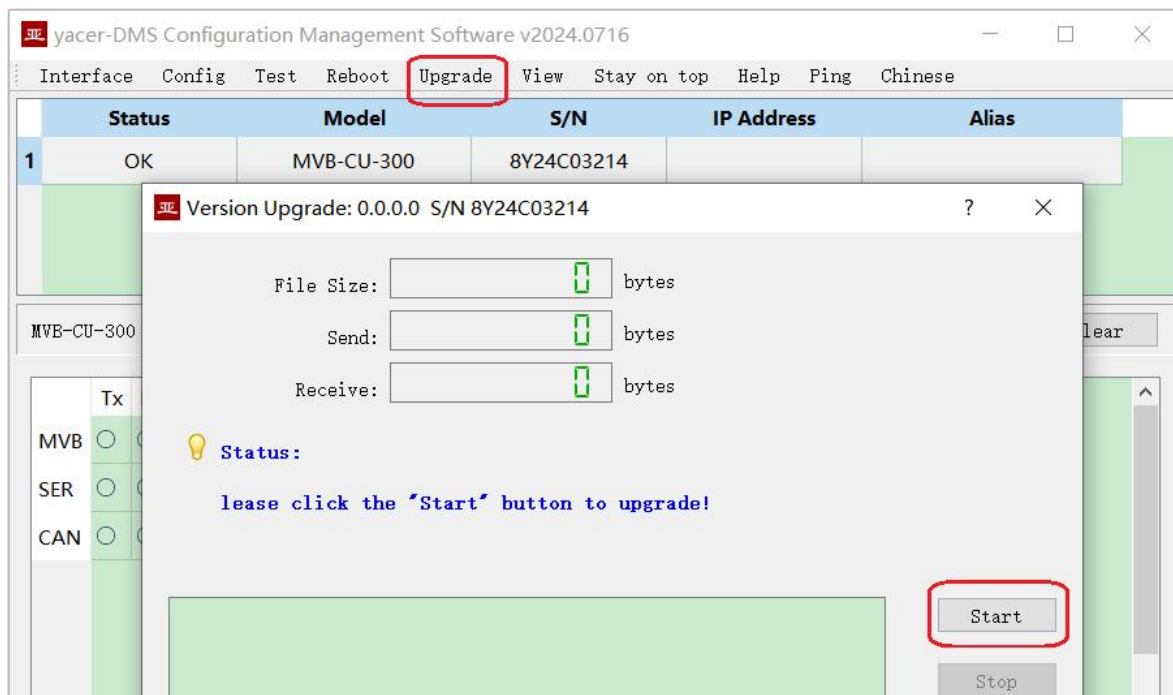

### 6.3.2 Select Version File

Pop up the "Select version file" dialog, and find the folder where the latest firmware version is stored, select the corresponding file, and click "Open" to start the update.

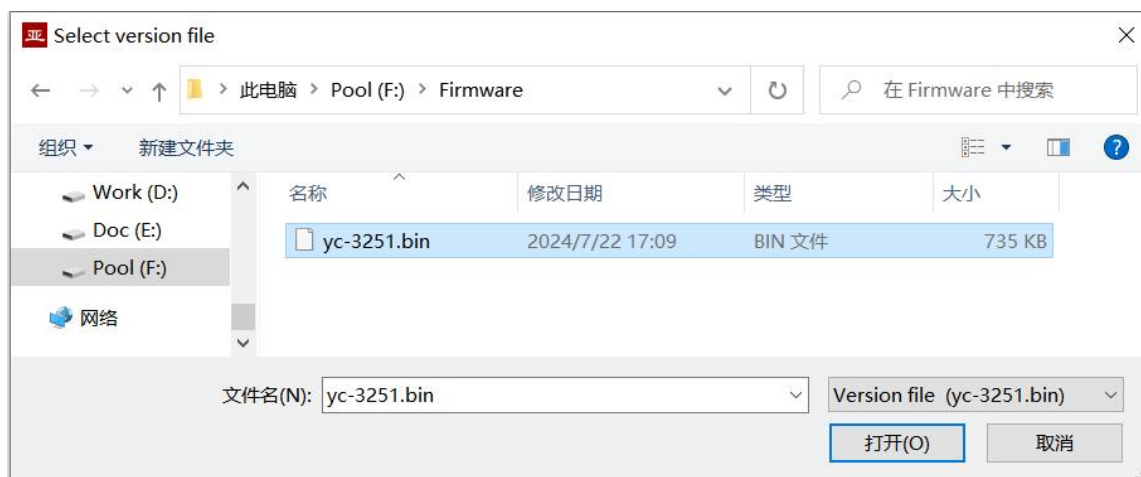

### 6.3.3 Complete Upgrade

When the page displays "Version upgrade complete" status, it indicates that the version upgrade is completed.

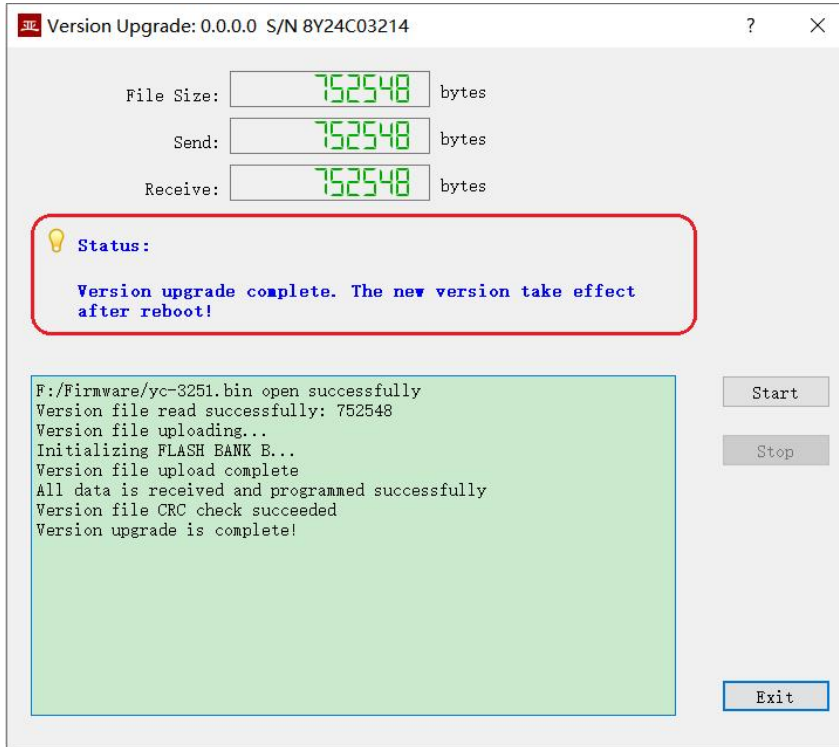

### 6.3.4 Confirm Upgrade

After the upgrade is completed, power up the device again, observe the version information in the statistical report, and determine whether the new version is successfully updated by the version date.

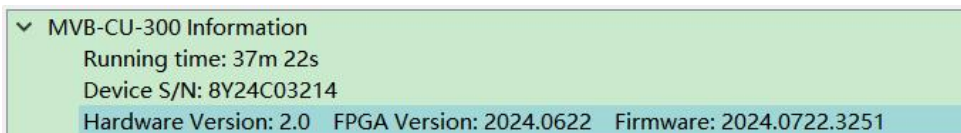

### 6.4 Reboot Device

Click the “Reboot” button on the toolbar to pop up the device reboot dialog, and then click the “Reboot” button to reboot the device.

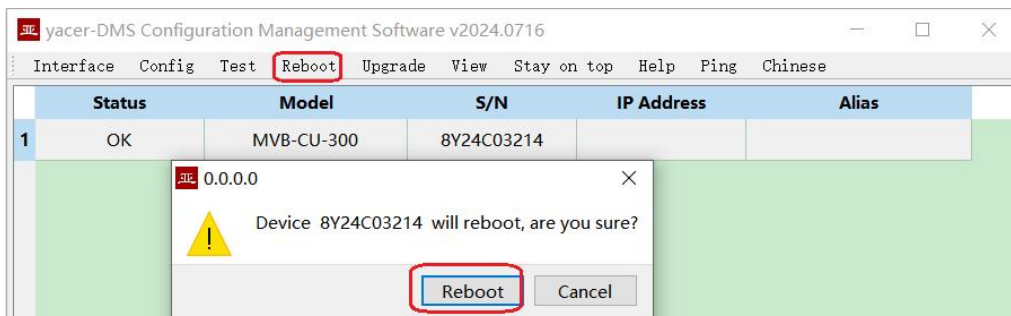

## About the Manual

- The manual is for reference only. If there is inconsistency between the manual and the actual product, the actual product shall prevail.
- We are not liable for any loss caused by the operations that do not comply with the manual.
- All the designs and software are subject to change without prior written notice. The product updates might cause some differences between the actual product and the manual. Please contact the customer service for the latest program and supplementary documentation.
- There still might be deviation in technical data, functions and operations description, or errors in print. If there is any doubt or dispute, we reserve the right of final explanation.
- Upgrade the reader software or try other mainstream reader software if the manual (in PDF format) cannot be opened.
- Please visit our website, contact the supplier or customer service if there is any problem occurring when using the device.
- If there is any uncertainty or controversy, we reserve the right of final explanation.